

**Exercise 13.1****Question 1:**

2 cubes each of volume  $64 \text{ cm}^3$  are joined end to end. Find the surface area of the resulting cuboids.

Answer:

Given that,

Volume of cubes =  $64 \text{ cm}^3$

(Edge)<sup>3</sup> = 64

Edge = 4 cm

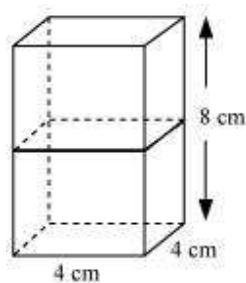

If cubes are joined end to end, the dimensions of the resulting cuboid will be 4 cm, 4 cm, 8 cm.

$$\begin{aligned}
 \therefore \text{Surface area of cuboids} &= 2(lb + bh + lh) \\
 &= 2(4 \times 4 + 4 \times 8 + 4 \times 8) \\
 &= 2(16 + 32 + 32) \\
 &= 2(16 + 64) \\
 &= 2 \times 80 = 160 \text{ cm}^2
 \end{aligned}$$

**Question 2:**

A vessel is in the form of a hollow hemisphere mounted by a hollow cylinder. The diameter of the hemisphere is 14 cm and the total height of the vessel is 13 cm. Find

the inner surface area of the vessel.  $\left[ \text{Use } \pi = \frac{22}{7} \right]$

Answer:

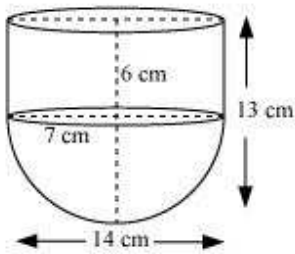

It can be observed that radius ( $r$ ) of the cylindrical part and the hemispherical part is the same (i.e., 7 cm).

Height of hemispherical part = Radius = 7 cm

Height of cylindrical part ( $h$ ) =  $13 - 7 = 6$  cm

Inner surface area of the vessel = CSA of cylindrical part + CSA of hemispherical part

$$= 2\pi r h + 2\pi r^2$$

$$\begin{aligned} \text{Inner surface area of vessel} &= 2 \times \frac{22}{7} \times 7 \times 6 + 2 \times \frac{22}{7} \times 7 \times 7 \\ &= 44(6 + 7) = 44 \times 13 \\ &= 572 \text{ cm}^2 \end{aligned}$$

### Question 3:

A toy is in the form of a cone of radius 3.5 cm mounted on a hemisphere of same radius. The total height of the toy is 15.5 cm. Find the total surface area of the toy.

$$\left[ \text{Use } \pi = \frac{22}{7} \right]$$

Answer:

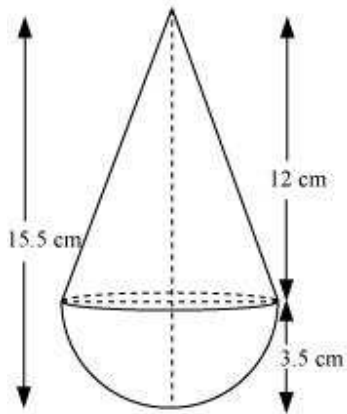

It can be observed that the radius of the conical part and the hemispherical part is same (i.e., 3.5 cm).

$$\text{Height of hemispherical part} = \text{Radius } (r) = 3.5 = \frac{7}{2} \text{ cm}$$

$$\text{Height of conical part } (h) = 15.5 - 3.5 = 12 \text{ cm}$$

$$\begin{aligned} \text{Slant height } (l) \text{ of conical part} &= \sqrt{r^2 + h^2} \\ &= \sqrt{\left(\frac{7}{2}\right)^2 + (12)^2} = \sqrt{\frac{49}{4} + 144} = \sqrt{\frac{49 + 576}{4}} \\ &= \sqrt{\frac{625}{4}} = \frac{25}{2} \end{aligned}$$

Total surface area of toy = CSA of conical part + CSA of hemispherical part

$$\begin{aligned} &= \pi r l + 2\pi r^2 \\ &= \frac{22}{7} \times \frac{7}{2} \times \frac{25}{2} + 2 \times \frac{22}{7} \times \frac{7}{2} \times \frac{7}{2} \\ &= 137.5 + 77 = 214.5 \text{ cm}^2 \end{aligned}$$

**Question 4:**

A cubical block of side 7 cm is surmounted by a hemisphere. What is the greatest

diameter the hemisphere can have? Find the surface area of the solid. [ Use  $\pi = \frac{22}{7}$  ]

Answer:

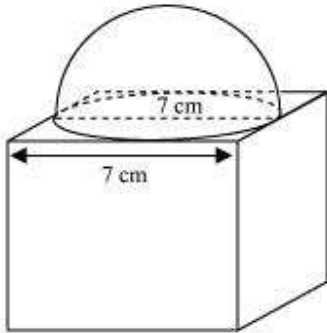

From the figure, it can be observed that the greatest diameter possible for such hemisphere is equal to the cube's edge, i.e., 7cm.

Radius ( $r$ ) of hemispherical part =  $\frac{7}{2} = 3.5\text{cm}$

Total surface area of solid = Surface area of cubical part + CSA of hemispherical part  
– Area of base of hemispherical part

$$= 6(\text{Edge})^2 + 2\pi r^2 - \pi r^2 = 6(\text{Edge})^2 + \pi r^2$$

$$\begin{aligned} \text{Total surface area of solid} &= 6(7)^2 + \frac{22}{7} \times \frac{7}{2} \times \frac{7}{2} \\ &= 294 + 38.5 = 332.5\text{cm}^2 \end{aligned}$$

**Question 5:**

A hemispherical depression is cut out from one face of a cubical wooden block such that the diameter  $l$  of the hemisphere is equal to the edge of the cube. Determine the surface area of the remaining solid.

Answer:

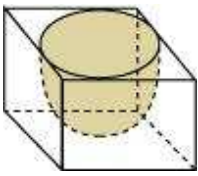

Diameter of hemisphere = Edge of cube =  $l$

Radius of hemisphere =  $\frac{l}{2}$

Total surface area of solid = Surface area of cubical part + CSA of hemispherical part  
 – Area of base of hemispherical part

$$= 6(\text{Edge})^2 + 2\pi r^2 - \pi r^2 = 6(\text{Edge})^2 + \pi r^2$$

$$\begin{aligned} \text{Total surface area of solid} &= 6l^2 + \pi \times \left(\frac{l}{2}\right)^2 \\ &= 6l^2 + \frac{\pi l^2}{4} \\ &= \frac{1}{4}(24 + \pi)l^2 \text{ unit}^2 \end{aligned}$$

**Question 6:**

A medicine capsule is in the shape of cylinder with two hemispheres stuck to each of its ends (see the given figure). The length of the entire capsule is 14 mm and the

diameter of the capsule is 5 mm. Find its surface area. [ Use  $\pi = \frac{22}{7}$  ]

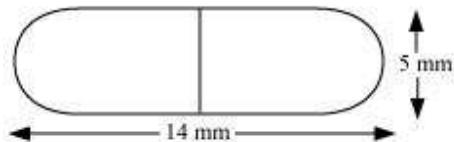

Answer:

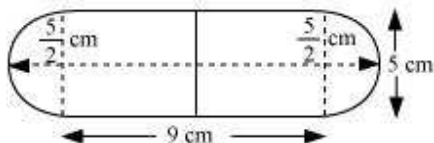

It can be observed that

Radius ( $r$ ) of cylindrical part = Radius ( $r$ ) of hemispherical part

$$= \frac{\text{Diameter of the capsule}}{2} = \frac{5}{2}$$

Length of cylindrical part ( $h$ ) = Length of the entire capsule  $- 2 \times r$

$$= 14 - 5 = 9 \text{ cm}$$

Surface area of capsule =  $2 \times \text{CSA of hemispherical part} + \text{CSA of cylindrical part}$

$$= 2 \times 2\pi r^2 + 2\pi r h$$

$$= 4\pi \left(\frac{5}{2}\right)^2 + 2\pi \left(\frac{5}{2}\right)(9)$$

$$= 25\pi + 45\pi$$

$$= 70\pi \text{ mm}^2$$

$$= 70 \times \frac{22}{7}$$

$$= 220 \text{ mm}^2$$

### Question 7:

A tent is in the shape of a cylinder surmounted by a conical top. If the height and diameter of the cylindrical part are 2.1 m and 4 m respectively, and the slant height of the top is 2.8 m, find the area of the canvas used for making the tent. Also, find the cost of the canvas of the tent at the rate of Rs 500 per  $\text{m}^2$ . (Note that the base of

the tent will not be covered with canvas.)  $\left[ \text{Use } \pi = \frac{22}{7} \right]$

Answer:

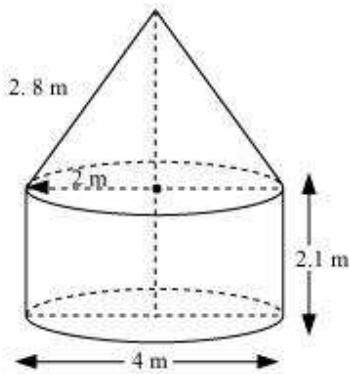

Given that,

Height ( $h$ ) of the cylindrical part = 2.1 m

Diameter of the cylindrical part = 4 m

Radius of the cylindrical part = 2 m

Slant height ( $l$ ) of conical part = 2.8 m

Area of canvas used = CSA of conical part + CSA of cylindrical part

$$= \pi r l + 2\pi r h$$

$$= \pi \times 2 \times 2.8 + 2\pi \times 2 \times 2.1$$

$$= 2\pi [2.8 + 2 \times 2.1] = 2\pi [2.8 + 4.2] = 2 \times \frac{22}{7} \times 7$$

$$= 44 \text{ m}^2$$

Cost of 1 m<sup>2</sup> canvas = Rs 500

Cost of 44 m<sup>2</sup> canvas = 44 × 500 = 22000

Therefore, it will cost Rs 22000 for making such a tent.

### Question 8:

From a solid cylinder whose height is 2.4 cm and diameter 1.4 cm, a conical cavity of the same height and same diameter is hollowed out. Find the total surface area of

the remaining solid to the nearest cm<sup>2</sup>.  $\left[ \text{Use } \pi = \frac{22}{7} \right]$

Answer:

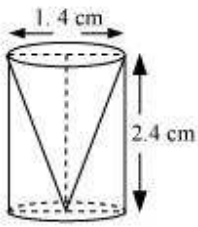

Given that,

Height ( $h$ ) of the conical part = Height ( $h$ ) of the cylindrical part = 2.4 cm

Diameter of the cylindrical part = 1.4 cm

Therefore, radius ( $r$ ) of the cylindrical part = 0.7 cm

$$\begin{aligned} \text{Slant height } (l) \text{ of conical part} &= \sqrt{r^2 + h^2} \\ &= \sqrt{(0.7)^2 + (2.4)^2} = \sqrt{0.49 + 5.76} \\ &= \sqrt{6.25} = 2.5 \end{aligned}$$

Total surface area of the remaining solid will be

= CSA of cylindrical part + CSA of conical part + Area of cylindrical base

$$\begin{aligned} &= 2\pi rh + \pi rl + \pi r^2 \\ &= 2 \times \frac{22}{7} \times 0.7 \times 2.4 + \frac{22}{7} \times 0.7 \times 2.5 + \frac{22}{7} \times 0.7 \times 0.7 \\ &= 4.4 \times 2.4 + 2.2 \times 2.5 + 2.2 \times 0.7 \\ &= 10.56 + 5.50 + 1.54 = 17.60 \text{ cm}^2 \end{aligned}$$

The total surface area of the remaining solid to the nearest  $\text{cm}^2$  is  $18 \text{ cm}^2$

### Question 9:

A wooden article was made by scooping out a hemisphere from each end of a solid cylinder, as shown in given figure. If the height of the cylinder is 10 cm, and its base

is of radius 3.5 cm, find the total surface area of the article.  $\left[ \text{Use } \pi = \frac{22}{7} \right]$



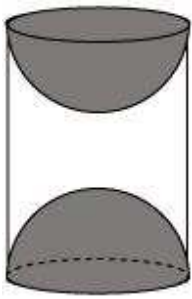

Answer:

Given that,

Radius ( $r$ ) of cylindrical part = Radius ( $r$ ) of hemispherical part = 3.5 cm

Height of cylindrical part ( $h$ ) = 10 cm

Surface area of article = CSA of cylindrical part + 2 × CSA of hemispherical part

$$= 2\pi rh + 2 \times 2\pi r^2$$

$$= 2\pi \times 3.5 \times 10 + 2 \times 2\pi \times 3.5 \times 3.5$$

$$= 70\pi + 49\pi$$

$$= 119\pi$$

$$= 17 \times 22 = 374 \text{ cm}^2$$

## Exercise 13.2

### Question 1:

A solid is in the shape of a cone standing on a hemisphere with both their radii being equal to 1 cm and the height of the cone is equal to its radius. Find the volume of the solid in terms of  $\pi$ .

Answer:

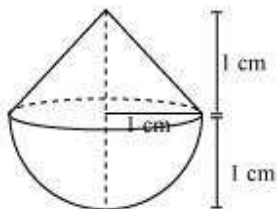

Given that,

Height ( $h$ ) of conical part = Radius( $r$ ) of conical part = 1 cm

Radius( $r$ ) of hemispherical part = Radius of conical part ( $r$ ) = 1 cm

Volume of solid = Volume of conical part + Volume of hemispherical part

$$\begin{aligned} &= \frac{1}{3}\pi r^2 h + \frac{2}{3}\pi r^3 \\ &= \frac{1}{3}\pi(1)^2(1) + \frac{2\pi}{3}\pi(1) = \frac{2\pi}{3} + \frac{\pi}{3} = \pi \text{ cm}^3 \end{aligned}$$

### Question 2:

Rachel, an engineering student, was asked to make a model shaped like a cylinder with two cones attached at its two ends by using a thin aluminum sheet. The diameter of the model is 3 cm and its length is 12 cm. If each cone has a height of 2 cm, find the volume of air contained in the model that Rachel made. (Assume the

outer and inner dimensions of the model to be nearly the same.)  $\left[ \text{Use } \pi = \frac{22}{7} \right]$

Answer:

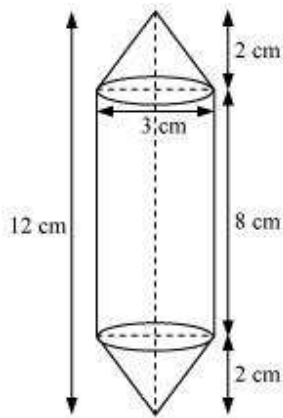

From the figure, it can be observed that

Height ( $h_1$ ) of each conical part = 2 cm

Height ( $h_2$ ) of cylindrical part = 12 - 2 × Height of conical part  
 = 12 - 2 × 2 = 8 cm

Radius ( $r$ ) of cylindrical part = Radius of conical part =  $\frac{3}{2}$  cm

Volume of air present in the model = Volume of cylinder + 2 × Volume of cones

$$= \pi r^2 h_2 + 2 \times \frac{1}{3} \pi r^2 h_1$$

$$= \pi \left( \frac{3}{2} \right)^2 (8) + 2 \times \frac{1}{3} \pi \left( \frac{3}{2} \right)^2 (2) = \pi \times \frac{9}{4} \times 8 + \frac{2}{3} \pi \times \frac{9}{4} \times 2$$

$$= 18\pi + 3\pi = 21\pi = 66 \text{ cm}^2$$

### Question 3:

A gulab jamun, contains sugar syrup up to about 30% of its volume. Find approximately how much syrup would be found in 45 gulab jamuns, each shaped like a cylinder with two hemispherical ends with length 5 cm and diameter 2.8 cm (see the given figure).

$$\left[ \text{Use } \pi = \frac{22}{7} \right]$$

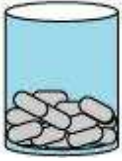

Answer:

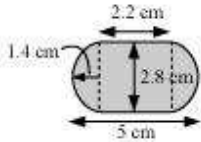

It can be observed that

$$\text{Radius } (r) \text{ of cylindrical part} = \text{Radius } (r) \text{ of hemispherical part} = \frac{2.8}{2} = 1.4 \text{ cm}$$

$$\text{Length of each hemispherical part} = \text{Radius of hemispherical part} = 1.4 \text{ cm}$$

$$\begin{aligned} \text{Length } (h) \text{ of cylindrical part} &= 5 - 2 \times \text{Length of hemispherical part} \\ &= 5 - 2 \times 1.4 = 2.2 \text{ cm} \end{aligned}$$

$$\text{Volume of one gulab jamun} = \text{Vol. of cylindrical part} + 2 \times \text{Vol. of hemispherical part}$$

$$\begin{aligned} &= \pi r^2 h + 2 \times \frac{2}{3} \pi r^3 = \pi r^2 h + \frac{4}{3} \pi r^3 \\ &= \pi \times (1.4)^2 \times 2.2 + \frac{4}{3} \pi (1.4)^3 \\ &= \frac{22}{7} \times 1.4 \times 1.4 \times 2.2 + \frac{4}{3} \times \frac{22}{7} \times 1.4 \times 1.4 \times 1.4 \\ &= 13.552 + 11.498 = 25.05 \text{ cm}^3 \end{aligned}$$

$$\text{Volume of 45 gulab jamuns} = 45 \times 25.05 = 1,127.25 \text{ cm}^3$$

$$\text{Volume of sugar syrup} = 30\% \text{ of volume}$$

$$= \frac{30}{100} \times 1,127.25$$

$$= 338.17 \text{ cm}^3$$

$$\approx 338 \text{ cm}^3$$

**Question 4:**

A pen stand made of wood is in the shape of a cuboid with four conical depressions to hold pens. The dimensions of the cuboids are 15 cm by 10 cm by 3.5 cm. The radius of each of the depressions is 0.5 cm and the depth is 1.4 cm. Find the volume of wood in the entire stand (see the following figure). [ Use  $\pi = \frac{22}{7}$  ]

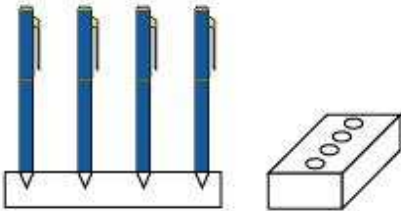

Answer:

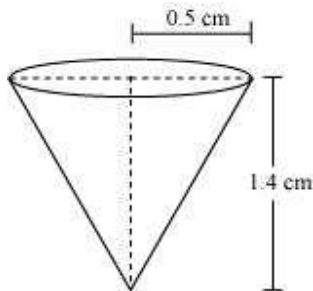

Depth ( $h$ ) of each conical depression = 1.4 cm

Radius ( $r$ ) of each conical depression = 0.5 cm

Volume of wood = Volume of cuboid – 4 × Volume of cones

$$=lbh - 4 \times \frac{1}{3} \pi r^2 h$$

$$=15 \times 10 \times 3.5 - 4 \times \frac{1}{3} \times \frac{22}{7} \times \left(\frac{1}{2}\right)^2 \times 1.4$$

$$=525 - 1.47$$

$$=523.53 \text{ cm}^3$$

**Question 5:**

A vessel is in the form of an inverted cone. Its height is 8 cm and the radius of its top, which is open, is 5 cm. It is filled with water up to the brim. When lead shots, each of which is a sphere of radius 0.5 cm are dropped into the vessel, one-fourth of the water flows out. Find the number of lead shots dropped in the vessel.

Answer:

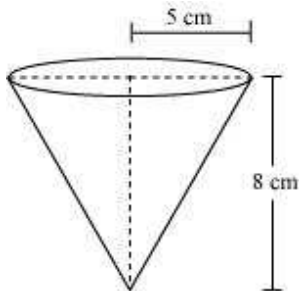

Height ( $h$ ) of conical vessel = 8 cm

Radius ( $r_1$ ) of conical vessel = 5 cm

Radius ( $r_2$ ) of lead shots = 0.5 cm

Let  $n$  number of lead shots were dropped in the vessel.

Volume of water spilled = Volume of dropped lead shots

$$\frac{1}{4} \times \text{Volume of cone} = n \times \frac{4}{3} r_2^3$$

$$\frac{1}{4} \times \frac{1}{3} \pi r_1^2 h = n \times \frac{4}{3} \pi r_2^3$$

$$r_1^2 h = n \times 16 r_2^3$$

$$5^2 \times 8 = n \times 16 \times (0.5)^3$$

$$n = \frac{25 \times 8}{16 \times \left(\frac{1}{2}\right)^3} = 100$$

Hence, the number of lead shots dropped in the vessel is 100.

#### Question 6:

A solid iron pole consists of a cylinder of height 220 cm and base diameter 24 cm, which is surmounted by another cylinder of height 60 cm and radius 8 cm. Find the mass of the pole, given that  $1 \text{ cm}^3$  of iron has approximately 8 g mass. [Use  $\pi = 3.14$ ]

Answer:

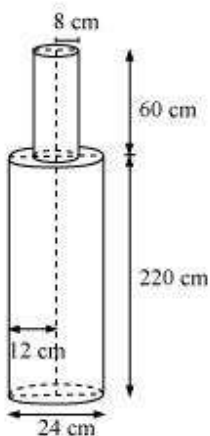

From the figure, it can be observed that  
Height ( $h_1$ ) of larger cylinder = 220 cm

24

Radius ( $r_1$ ) of larger cylinder =  $\frac{24}{2} = 12$  cm

Height ( $h_2$ ) of smaller cylinder = 60 cm

Radius ( $r_2$ ) of smaller cylinder = 8 cm

Total volume of pole = Volume of larger cylinder + Volume of smaller cylinder

$$\begin{aligned} &= \pi r_1^2 h_1 + \pi r_2^2 h_2 \\ &= \pi (12)^2 \times 220 + \pi (8)^2 \times 60 \\ &= \pi [144 \times 220 + 64 \times 60] \\ &= 35520 \times 3.14 = 1,11,532.8 \text{ cm}^3 \end{aligned}$$

Mass of  $1 \text{ cm}^3$  iron = 8 g

Mass of  $111532.8 \text{ cm}^3$  iron =  $111532.8 \times 8 = 892262.4 \text{ g} = 892.262 \text{ kg}$

### Question 7:

A solid consisting of a right circular cone of height 120 cm and radius 60 cm standing on a hemisphere of radius 60 cm is placed upright in a right circular cylinder full of water such that it touches the bottom. Find the volume of water left in the cylinder,

$\left[ \text{Use } \pi = \frac{22}{7} \right]$

if the radius of the cylinder is 60 cm and its height is 180 cm.

Answer:

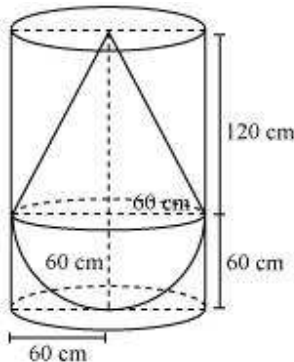



Radius ( $r$ ) of hemispherical part = Radius ( $r$ ) of conical part = 60 cm

Height ( $h_2$ ) of conical part of solid = 120 cm

Height ( $h_1$ ) of cylinder = 180 cm

Radius ( $r$ ) of cylinder = 60 cm

Volume of water left = Volume of cylinder – Volume of solid

= Volume of cylinder – (Volume of cone + Volume of hemisphere)

$$= \pi r^2 h_1 - \left( \frac{1}{3} \pi r^2 h_2 + \frac{2}{3} \pi r^3 \right)$$

$$= \pi (60)^2 (180) - \left( \frac{1}{3} \pi (60)^2 \times 120 + \frac{2}{3} \pi (60)^3 \right)$$

$$= \pi (60)^2 [(180) - (40 + 40)]$$

$$= \pi (3,600)(100) = 3,60,000\pi \text{ cm}^3 = 1131428.57 \text{ cm}^3 = 1.131 \text{ m}^3$$

### Question 8:

A spherical glass vessel has a cylindrical neck 8 cm long, 2 cm in diameter; the diameter of the spherical part is 8.5 cm. By measuring the amount of water it holds, a child finds its volume to be  $345 \text{ cm}^3$ . Check whether she is correct, taking the above as the inside measurements, and  $\pi = 3.14$ .

Answer:

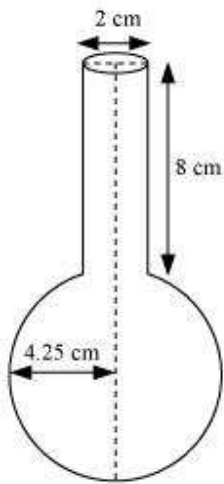

Height ( $h$ ) of cylindrical part = 8 cm

Radius ( $r_2$ ) of cylindrical part =  $\frac{2}{2} = 1$  cm

Radius ( $r_1$ ) spherical part =  $\frac{8.5}{2} = 4.25$  cm

Volume of vessel = Volume of sphere + Volume of cylinder

$$= \frac{4}{3} \pi r_1^3 + \pi r_2^2 h$$

$$= \frac{4}{3} \pi \left( \frac{8.5}{2} \right)^3 + \pi (1)^2 (8)$$

$$= \frac{4}{3} \times 3.14 \times 76.765625 + 8 \times 3.14$$

$$= 321.392 + 25.12$$

$$= 346.512$$

$$= 346.51 \text{ cm}^3$$

Hence, she is wrong.

### Exercise 13.3

#### Question 1:

A metallic sphere of radius 4.2 cm is melted and recast into the shape of a cylinder of radius 6 cm. Find the height of the cylinder.

Answer:

Radius ( $r_1$ ) of hemisphere = 4.2 cm

Radius ( $r_2$ ) of cylinder = 6 cm

Let the height of the cylinder be  $h$ .

The object formed by recasting the hemisphere will be the same in volume.

Volume of sphere = Volume of cylinder

$$\frac{4}{3}\pi r_1^3 = \pi r_2^2 h$$

$$\frac{4}{3}\pi(4.2)^3 = \pi(6)^2 h$$

$$\frac{4}{3} \times \frac{4.2 \times 4.2 \times 4.2}{36} = h$$

$$h = (1.4)^3 = 2.74 \text{ cm}$$

Hence, the height of the cylinder so formed will be 2.74 cm.

#### Question 2:

Metallic spheres of radii 6 cm, 8 cm, and 10 cm, respectively, are melted to form a single solid sphere. Find the radius of the resulting sphere.

Answer:

Radius ( $r_1$ ) of 1<sup>st</sup> sphere = 6 cm

Radius ( $r_2$ ) of 2<sup>nd</sup> sphere = 8 cm

Radius ( $r_3$ ) of 3<sup>rd</sup> sphere = 10 cm

Let the radius of the resulting sphere be  $r$ .

The object formed by recasting these spheres will be same in volume as the sum of the volumes of these spheres.

Volume of 3 spheres = Volume of resulting sphere

$$\frac{4}{3}\pi[r_1^3 + r_2^3 + r_3^3] = \frac{4}{3}\pi r^3$$

$$\frac{4}{3}\pi[6^3 + 8^3 + 10^3] = \frac{4}{3}\pi r^3$$

$$r^3 = 216 + 512 + 1000 = 1728$$

$$r = 12 \text{ cm}$$

Therefore, the radius of the sphere so formed will be 12 cm.

### Question 3:

A 20 m deep well with diameter 7 m is dug and the earth from digging is evenly spread out to form a platform 22 m by 14 m. Find the height of the platform.

$$\left[ \text{Use } \pi = \frac{22}{7} \right]$$

Answer:

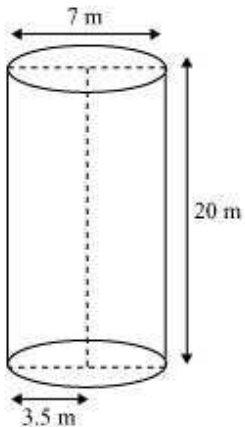

The shape of the well will be cylindrical.

Depth ( $h$ ) of well = 20 m

Radius ( $r$ ) of circular end of well =  $\frac{7}{2}$  m

Area of platform = Length  $\times$  Breadth =  $22 \times 14 \text{ m}^2$

Let height of the platform =  $H$

Volume of soil dug from the well will be equal to the volume of soil scattered on the platform.

Volume of soil from well = Volume of soil used to make such platform

$$\pi \times r^2 \times h = \text{Area of platform} \times \text{Height of platform}$$

$$\pi \times \left(\frac{7}{2}\right)^2 \times 20 = 22 \times 14 \times H$$

$$\therefore H = \frac{22}{7} \times \frac{49}{4} \times \frac{20}{22 \times 14} = \frac{5}{2} \text{ m} = 2.5 \text{ m}$$

Therefore, the height of such platform will be 2.5 m.

#### Question 4:

A well of diameter 3 m is dug 14 m deep. The earth taken out of it has been spread evenly all around it in the shape of a circular ring of width 4 m to form an embankment. Find the height of the embankment.

Answer:

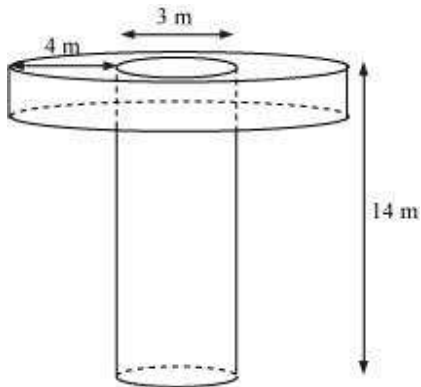

The shape of the well will be cylindrical.

Depth ( $h_1$ ) of well = 14 m

Radius ( $r_1$ ) of the circular end of well =  $\frac{3}{2}$  m

Width of embankment = 4 m

From the figure, it can be observed that our embankment will be in a cylindrical

shape having outer radius ( $r_2$ ) as  $4 + \frac{3}{2} = \frac{11}{2}$  m and inner radius ( $r_1$ ) as  $\frac{3}{2}$  m.

Let the height of embankment be  $h_2$ .

Volume of soil dug from well = Volume of earth used to form embankment

$$\pi \times r_1^2 \times h_1 = \pi \times (r_2^2 - r_1^2) \times h_2$$

$$\pi \times \left(\frac{3}{2}\right)^2 \times 14 = \pi \times \left[\left(\frac{11}{2}\right)^2 - \left(\frac{3}{2}\right)^2\right] \times h$$

$$\frac{9}{4} \times 14 = \frac{112}{4} \times h$$

$$h = \frac{9}{8} = 1.125 \text{ m}$$

Therefore, the height of the embankment will be 1.125 m.

### Question 5:

A container shaped like a right circular cylinder having diameter 12 cm and height 15 cm is full of ice cream. The ice cream is to be filled into cones of height 12 cm and diameter 6 cm, having a hemispherical shape on the top. Find the number of such cones which can be filled with ice cream.

Answer:

Height ( $h_1$ ) of cylindrical container = 15 cm

Radius ( $r_1$ ) of circular end of container =  $\frac{12}{2} = 6$  cm

Radius ( $r_2$ ) of circular end of ice-cream cone =  $\frac{6}{2} = 3$  cm

Height ( $h_2$ ) of conical part of ice-cream cone = 12 cm

Let  $n$  ice-cream cones be filled with ice-cream of the container.

Volume of ice-cream in cylinder =  $n \times$  (Volume of 1 ice-cream cone + Volume of hemispherical shape on the top)

$$\pi r_1^2 h_1 = n \left( \frac{1}{3} \pi r_2^2 h_2 + \frac{2}{3} \pi r_2^3 \right)$$

$$n = \frac{6^2 \times 15}{\frac{1}{3} \times 9 \times 12 + \frac{2}{3} \times (3)^3}$$

$$n = \frac{36 \times 15 \times 3}{108 + 54}$$

$$n = 10$$

Therefore, 10 ice-cream cones can be filled with the ice-cream in the container.

### Question 6:

How many silver coins, 1.75 cm in diameter and of thickness 2 mm, must be melted

to form a cuboid of dimensions 5.5 cm × 10 cm × 3.5 cm? Use  $\pi = \frac{22}{7}$

Answer:



Coins are cylindrical in shape.

Height ( $h_1$ ) of cylindrical coins = 2 mm = 0.2 cm

Radius ( $r$ ) of circular end of coins =  $\frac{1.75}{2} = 0.875$  cm

Let  $n$  coins be melted to form the required cuboids.

Volume of  $n$  coins = Volume of cuboids

$$n \times \pi \times r^2 \times h_1 = l \times b \times h$$

$$n \times \pi \times (0.875)^2 \times 0.2 = 5.5 \times 10 \times 3.5$$

$$n = \frac{5.5 \times 10 \times 3.5 \times 7}{(0.875)^2 \times 0.2 \times 22} = 400$$

Therefore, the number of coins melted to form such a cuboid is 400.

### Question 7:

A cylindrical bucket, 32 cm high and with radius of base 18 cm, is filled with sand. This bucket is emptied on the ground and a conical heap of sand is formed. If the height of the conical heap is 24 cm. Find the radius and slant height of the heap.

Answer:

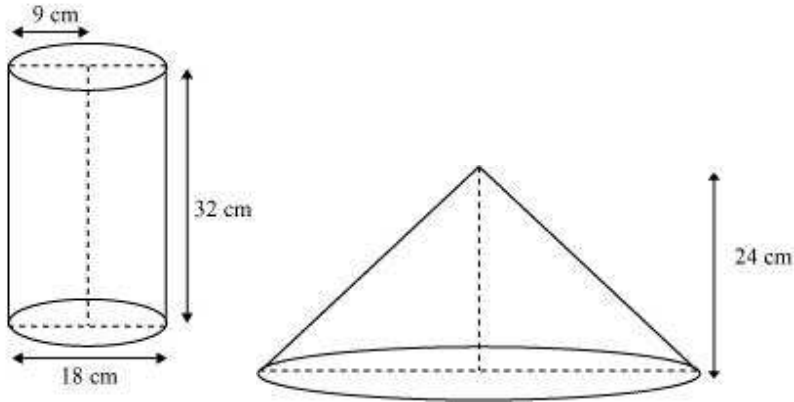

Height ( $h_1$ ) of cylindrical bucket = 32 cm

Radius ( $r_1$ ) of circular end of bucket = 18 cm

Height ( $h_2$ ) of conical heap = 24 cm

Let the radius of the circular end of conical heap be  $r_2$ .

The volume of sand in the cylindrical bucket will be equal to the volume of sand in the conical heap.

Volume of sand in the cylindrical bucket = Volume of sand in conical heap

$$\pi \times r_1^2 \times h_1 = \frac{1}{3} \pi \times r_2^2 \times h_2$$

$$\pi \times 18^2 \times 32 = \frac{1}{3} \pi \times r_2^2 \times 24$$

$$\pi \times 18^2 \times 32 = \frac{1}{3} \pi \times r_2^2 \times 24$$

$$r_2^2 = \frac{3 \times 18^2 \times 32}{24} = 18^2 \times 4$$



$$r_2 = 18 \times 2 = 36 \text{ cm}$$

$$\text{Slant height} = \sqrt{36^2 + 24^2} = \sqrt{12^2 \times (3^2 + 2^2)} = 12\sqrt{13} \text{ cm}$$

Therefore, the radius and slant height of the conical heap are 36 cm and  $12\sqrt{13}$  cm respectively

**Question 8:**

Water in canal, 6 m wide and 1.5 m deep, is flowing with a speed of 10 km/h. how much area will it irrigate in 30 minutes, if 8 cm of standing water is needed?

Answer:

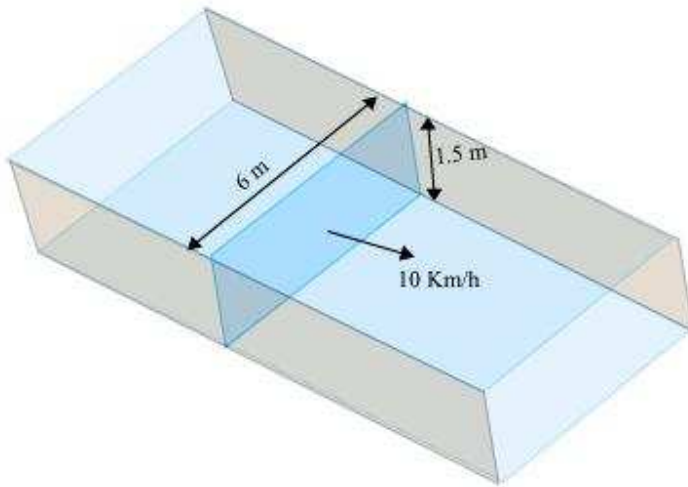

Consider an area of cross-section of canal as ABCD.

$$\text{Area of cross-section} = 6 \times 1.5 = 9 \text{ m}^2$$

$$\text{Speed of water} = 10 \text{ km/h} = \frac{10000}{60} \text{ metre/min}$$

$$\text{Volume of water that flows in 1 minute from canal} = 9 \times \frac{10000}{60} = 1500 \text{ m}^3$$

$$\text{Volume of water that flows in 30 minutes from canal} = 30 \times 1500 = 45000 \text{ m}^3$$

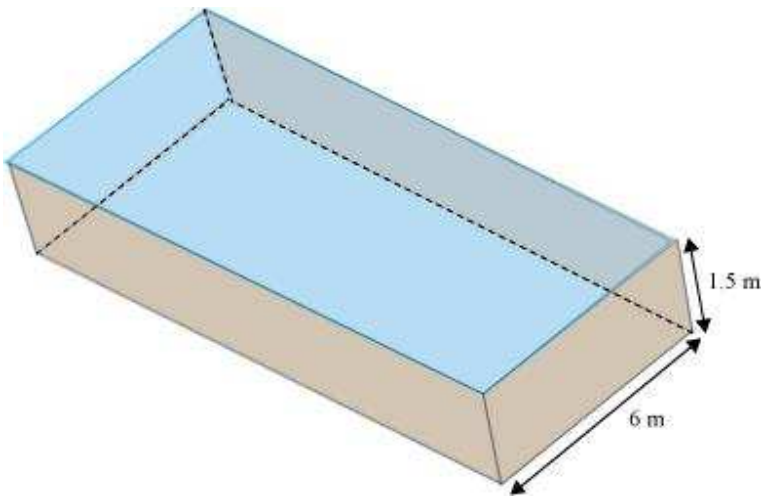

Let the irrigated area be A. Volume of water irrigating the required area will be equal to the volume of water that flowed in 30 minutes from the canal.

Vol. of water flowing in 30 minutes from canal = Vol. of water irrigating the reqd. area

$$45000 = \frac{A \times 8}{100}$$

$$A = 562500 \text{ m}^2$$

Therefore, area irrigated in 30 minutes is 562500 m<sup>2</sup>.

### Question 9:

A farmer connects a pipe of internal diameter 20 cm from a canal into a cylindrical tank in her field, which is 10 m in diameter and 2 m deep. If water flows through the pipe at the rate of 3 km/h, in how much time will the tank be filled?

Answer:



Consider an area of cross-section of pipe as shown in the figure.

$$\text{Radius } (r_1) \text{ of circular end of pipe} = \frac{20}{200} = 0.1 \text{ m}$$

$$\text{Area of cross-section} = \pi \times r_1^2 = \pi \times (0.1)^2 = 0.01\pi \text{ m}^2$$

$$\text{Speed of water} = 3 \text{ km/h} = \frac{3000}{60} = 50 \text{ metre/min}$$

$$\text{Volume of water that flows in 1 minute from pipe} = 50 \times 0.01\pi = 0.5\pi \text{ m}^3$$

$$\text{Volume of water that flows in } t \text{ minutes from pipe} = t \times 0.5\pi \text{ m}^3$$

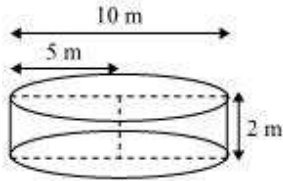

$$\text{Radius } (r_2) \text{ of circular end of cylindrical tank} = \frac{10}{2} = 5 \text{ m}$$

$$\text{Depth } (h_2) \text{ of cylindrical tank} = 2 \text{ m}$$

Let the tank be filled completely in  $t$  minutes.

Volume of water filled in tank in  $t$  minutes is equal to the volume of water flowed in  $t$  minutes from the pipe.

Volume of water that flows in  $t$  minutes from pipe = Volume of water in tank

$$t \times 0.5\pi = \pi \times (r_2)^2 \times h_2$$

$$t \times 0.5 = 5^2 \times 2$$

$$t = 100$$

Therefore, the cylindrical tank will be filled in 100 minutes.

### Exercise 13.4

#### Question 1:

A drinking glass is in the shape of a frustum of a cone of height 14 cm. The diameters of its two circular ends are 4 cm and 2 cm. Find the capacity of the glass.

$$\left[ \text{Use } \pi = \frac{22}{7} \right]$$

Answer:

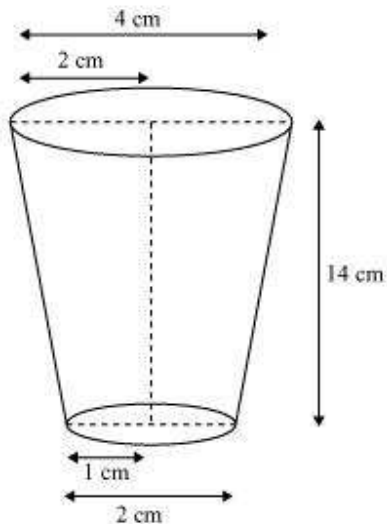

Radius ( $r_1$ ) of upper base of glass =  $\frac{4}{2} = 2$  cm

Radius ( $r_2$ ) of lower base of glass =  $\frac{2}{2} = 1$  cm

Capacity of glass = Volume of frustum of cone

$$\begin{aligned}
&= \frac{1}{3} \pi h (r_1^2 + r_2^2 + r_1 r_2) \\
&= \frac{1}{3} \pi h [(2)^2 + (1)^2 + (2)(1)] \\
&= \frac{1}{3} \times \frac{22}{7} \times 14 [4 + 1 + 2] \\
&= \frac{308}{3} = 102 \frac{2}{3} \text{ cm}^3
\end{aligned}$$

Therefore, the capacity of the glass is  $102 \frac{2}{3} \text{ cm}^3$ .

### Question 2:

The slant height of a frustum of a cone is 4 cm and the perimeters (circumference) of its circular ends are 18 cm and 6 cm. find the curved surface area of the frustum.

Answer:

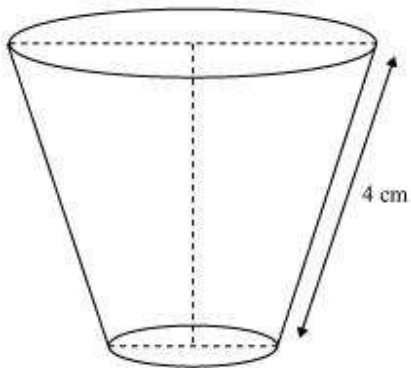

Perimeter of upper circular end of frustum = 18

$$2\pi r_1 = 18$$

$$r_1 = \frac{9}{\pi}$$

Perimeter of lower end of frustum = 6 cm

$$2\pi r_2 = 6$$

$$r_2 = \frac{3}{\pi}$$

Slant height ( $l$ ) of frustum = 4

CSA of frustum =  $\pi (r_1 + r_2) l$

$$= \pi \left( \frac{9}{\pi} + \frac{3}{\pi} \right) 4$$

$$= 12 \times 4$$

$$= 48 \text{ cm}^2$$

Therefore, the curved surface area of the frustum is  $48 \text{ cm}^2$ .

### Question 3:

A *fez*, the cap used by the Turks, is shaped like the frustum of a cone (see the figure given below). If its radius on the open side is 10 cm, radius at the upper base is 4 cm and its slant height is 15 cm, find the area of material use for making it.

$$\left[ \text{Use } \pi = \frac{22}{7} \right]$$



Answer:

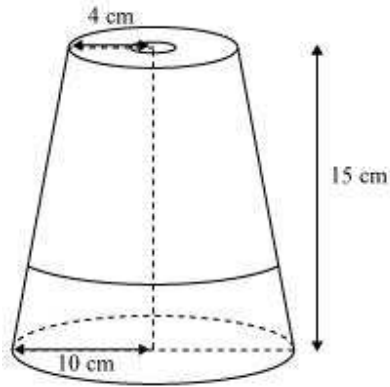

Radius ( $r_2$ ) at upper circular end = 4 cm

Radius ( $r_1$ ) at lower circular end = 10 cm

Slant height ( $l$ ) of frustum = 15 cm

Area of material used for making the fez = CSA of frustum + Area of upper circular end

$$\begin{aligned} &= \pi (r_1 + r_2)l + \pi r_2^2 \\ &= \pi (10 + 4) 15 + \pi (4)^2 \\ &= \pi (14) 15 + 16 \pi \\ &= 210\pi + 16\pi = \frac{226 \times 22}{7} \\ &= 710\frac{2}{7} \text{ cm}^2 \end{aligned}$$

Therefore, the area of material used for making it is  $710\frac{2}{7} \text{ cm}^2$ .

#### Question 4:

A container, opened from the top and made up of a metal sheet, is in the form of a frustum of a cone of height 16 cm with radii of its lower and upper ends as 8 cm and 20 cm respectively. Find the cost of the milk which can completely fill the container,

at the rate of Rs.20 per litre. Also find the cost of metal sheet used to make the container, if it costs Rs.8 per 100 cm<sup>2</sup>. [Take  $\pi = 3.14$ ]

Answer:

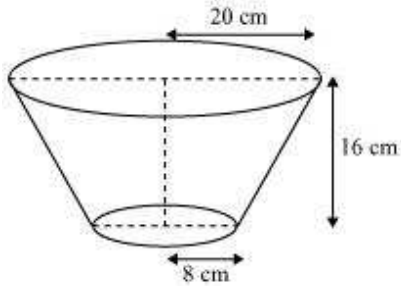

Radius ( $r_1$ ) of upper end of container = 20 cm

Radius ( $r_2$ ) of lower end of container = 8 cm

Height ( $h$ ) of container = 16 cm

$$\begin{aligned}\text{Slant height } (l) \text{ of frustum} &= \sqrt{(r_1 - r_2)^2 + h^2} \\ &= \sqrt{(20 - 8)^2 + (16)^2} \\ &= \sqrt{(12)^2 + (16)^2} = \sqrt{144 + 256} \\ &= 20 \text{ cm}\end{aligned}$$

Capacity of container = Volume of frustum

$$\begin{aligned}&= \frac{1}{3} \pi h (r_1^2 + r_2^2 + r_1 r_2) \\ &= \frac{1}{3} \times 3.14 \times 16 \times [(20)^2 + (8)^2 + (20)(8)] \\ &= \frac{1}{3} \times 3.14 \times 16 (400 + 64 + 160) \\ &= \frac{1}{3} \times 3.14 \times 16 \times 624 \\ &= 10449.92 \text{ cm}^3 \\ &= 10.45 \text{ litres.}\end{aligned}$$

Cost of 1 litre milk = Rs 20



$$\text{Cost of 10.45 litre milk} = 10.45 \times 20$$

$$= \text{Rs } 209$$

Area of metal sheet used to make the container

$$= \pi (r_1 + r_2)l + \pi r_2^2$$

$$= \pi (20 + 8) 20 + \pi (8)^2$$

$$= 560 \pi + 64 \pi = 624 \pi \text{ cm}^2$$

Cost of  $100 \text{ cm}^2$  metal sheet = Rs 8

$$\begin{aligned} \text{Cost of } 624 \pi \text{ cm}^2 \text{ metal sheet} &= \frac{624 \times 3.14 \times 8}{100} \\ &= 156.75 \end{aligned}$$

Therefore, the cost of the milk which can completely fill the container is

Rs 209 and the cost of metal sheet used to make the container is Rs 156.75.

#### Question 5:

A metallic right circular cone 20 cm high and whose vertical angle is  $60^\circ$  is cut into two parts at the middle of its height by a plane parallel to its base. If the frustum so

obtained is drawn into a wire of diameter  $\frac{1}{16}$  cm, find the length of the wire.

$$\left[ \text{Use } \pi = \frac{22}{7} \right]$$

Answer:

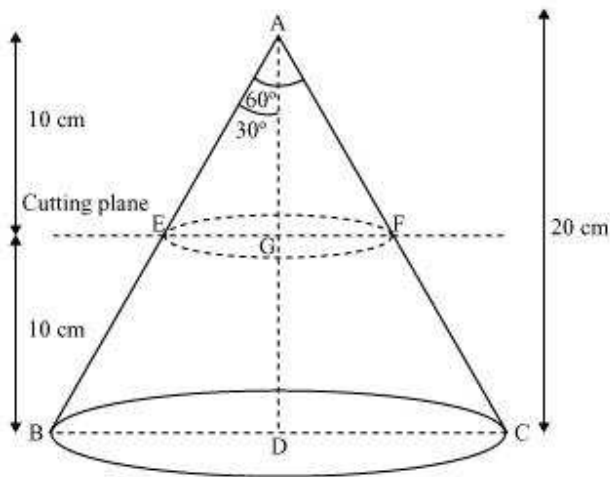

In  $\triangle AEG$ ,

$$\frac{EG}{AG} = \tan 30^\circ$$

$$EG = \frac{10}{\sqrt{3}} \text{ cm} = \frac{10\sqrt{3}}{3}$$

In  $\triangle ABD$ ,

$$\frac{BD}{AD} = \tan 30^\circ$$

$$BD = \frac{20}{\sqrt{3}} = \frac{20\sqrt{3}}{3} \text{ cm}$$

$$\text{Radius } (r_1) \text{ of upper end of frustum} = \frac{10\sqrt{3}}{3} \text{ cm}$$

$$\text{Radius } (r_2) \text{ of lower end of container} = \frac{20\sqrt{3}}{3} \text{ cm}$$

Height ( $h$ ) of container = 10 cm

$$\text{Volume of frustum} = \frac{1}{3} \pi h (r_1^2 + r_2^2 + r_1 r_2)$$

$$\begin{aligned}
&= \frac{1}{3} \times \pi \times 10 \left[ \left( \frac{10\sqrt{3}}{3} \right)^2 + \left( \frac{20\sqrt{3}}{3} \right)^2 + \frac{(10\sqrt{3})(20\sqrt{3})}{3 \times 3} \right] \\
&= \frac{10}{3} \pi \left[ \frac{100}{3} + \frac{400}{3} + \frac{200}{3} \right] \\
&= \frac{10}{3} \times \frac{22}{7} \times \frac{700}{3} = \frac{22000}{9} \text{ cm}^3
\end{aligned}$$

$$\text{Radius } (r) \text{ of wire} = \frac{1}{16} \times \frac{1}{2} = \frac{1}{32} \text{ cm}$$

Let the length of wire be  $l$ .

Volume of wire = Area of cross-section  $\times$  Length

$$\begin{aligned}
&= (\pi r^2) (l) \\
&= \pi \left( \frac{1}{32} \right)^2 \times l
\end{aligned}$$

Volume of frustum = Volume of wire

$$\frac{22000}{9} = \frac{22}{7} \times \left( \frac{1}{32} \right)^2 \times l$$

$$\frac{7000}{9} \times 1024 = l$$

$$\begin{aligned}
l &= 796444.44 \text{ cm} \\
&= 7964.44 \text{ metres}
\end{aligned}$$

### Exercise 13.5

#### Question 1:

A copper wire, 3 mm in diameter, is wound about a cylinder whose length is 12 cm, and diameter 10 cm, so as to cover the curved surface of the cylinder. Find the length and mass of the wire, assuming the density of copper to be 8.88 g per  $\text{cm}^3$ .

Answer:

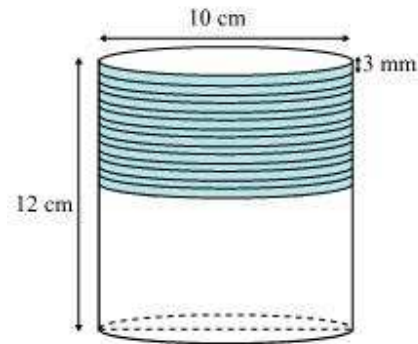

It can be observed that 1 round of wire will cover 3 mm height of cylinder.

$$\begin{aligned}\text{Number of rounds} &= \frac{\text{Height of cylinder}}{\text{Diameter of wire}} \\ &= \frac{12}{0.3} = 40 \text{ rounds}\end{aligned}$$

Length of wire required in 1 round = Circumference of base of cylinder

$$= 2\pi r = 2\pi \times 5 = 10\pi$$

Length of wire in 40 rounds =  $40 \times 10\pi$

$$= \frac{400 \times 22}{7} = \frac{8800}{7}$$

$$= 1257.14 \text{ cm} = 12.57 \text{ m}$$

$$\text{Radius of wire} = \frac{0.3}{2} = 0.15 \text{ cm}$$

Volume of wire = Area of cross-section of wire  $\times$  Length of wire

$$= \pi(0.15)^2 \times 1257.14$$

$$= 88.898 \text{ cm}^3$$

$$\text{Mass} = \text{Volume} \times \text{Density}$$

$$= 88.898 \times 8.88$$

$$= 789.41 \text{ gm}$$

### Question 2:

A right triangle whose sides are 3 cm and 4 cm (other than hypotenuse) is made to revolve about its hypotenuse. Find the volume and surface area of the double cone so formed. (Choose value of  $\pi$  as found appropriate.)

Answer:

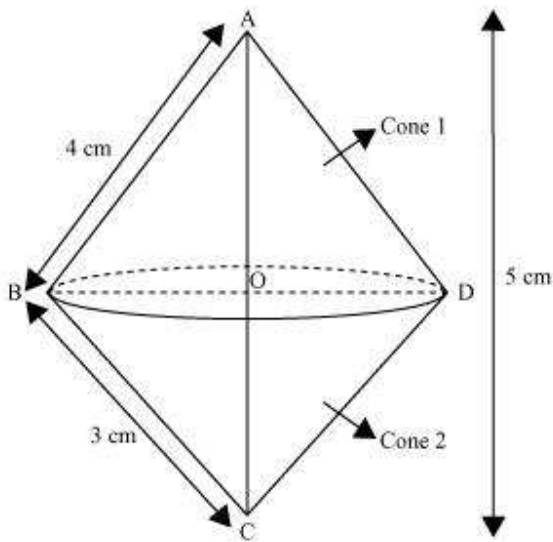

The double cone so formed by revolving this right-angled triangle ABC about its hypotenuse is shown in the figure.

$$\text{Hypotenuse } AC = \sqrt{3^2 + 4^2}$$

$$= \sqrt{25} = 5 \text{ cm}$$

$$\text{Area of } \triangle ABC = \frac{1}{2} \times AB \times BC$$

$$\frac{1}{2} \times AC \times OB = \frac{1}{2} \times 4 \times 3$$

$$\frac{1}{2} \times 5 \times OB = 6$$

$$OB = \frac{12}{5} = 2.4 \text{ cm}$$

Volume of double cone = Volume of cone 1 + Volume of cone 2

$$= \frac{1}{3} \pi r^2 h_1 + \frac{1}{3} \pi r^2 h_2$$

$$= \frac{1}{3} \pi r^2 (h_1 + h_2) = \frac{1}{3} \pi r^2 (OA + OC)$$

$$= \frac{1}{3} \times 3.14 \times (2.4)^2 (5)$$

$$= 30.14 \text{ cm}^3$$

Surface area of double cone = Surface area of cone 1 + Surface area of cone 2

$$= \pi r l_1 + \pi r l_2$$

$$= \pi r [4 + 3] = 3.14 \times 2.4 \times 7$$

$$= 52.75 \text{ cm}^2$$

### Question 3:

A cistern, internally measuring 150 cm × 120 cm × 110 cm, has 129600 cm<sup>3</sup> of water in it. Porous bricks are placed in the water until the cistern is full to the brim. Each brick absorbs one-seventeenth of its own volume of water. How many bricks can be put in without overflowing the water, each brick being 22.5 cm × 7.5 cm × 6.5 cm?

Answer:

$$\text{Volume of cistern} = 150 \times 120 \times 110$$

$$= 1980000 \text{ cm}^3$$

$$\text{Volume to be filled in cistern} = 1980000 - 129600$$

$$= 1850400 \text{ cm}^3$$

Let  $n$  numbers of porous bricks were placed in the cistern.

$$\text{Volume of } n \text{ bricks} = n \times 22.5 \times 7.5 \times 6.5$$

$$= 1096.875n$$

As each brick absorbs one-seventeenth of its volume, therefore, volume absorbed by

$$\text{these bricks} = \frac{n}{17}(1096.875)$$

$$1850400 + \frac{n}{17}(1096.875) = (1096.875)n$$

$$1850400 = \frac{16n}{17}(1096.875)$$

$$n = 1792.41$$

Therefore, 1792 bricks were placed in the cistern.

#### Question 5:

An oil funnel made of tin sheet consists of a 10 cm long cylindrical portion attached to a frustum of a cone. If the total height is 22 cm, diameter of the cylindrical portion is 8 cm and the diameter of the top of the funnel is 18 cm, find the area of the tin sheet required to make the funnel (see the given figure).

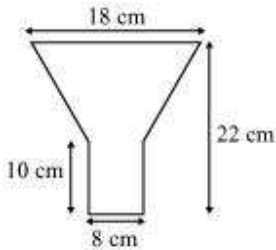

Answer:

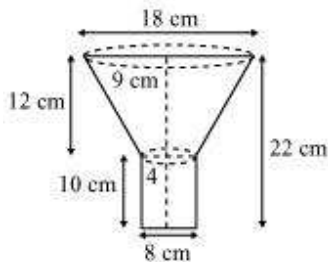

$$= \frac{18}{2} = 9 \text{ cm}$$

Radius ( $r_1$ ) of upper circular end of frustum part

Radius ( $r_2$ ) of lower circular end of frustum part = Radius of circular end of cylindrical part

$$= \frac{8}{2} = 4 \text{ cm}$$

Height ( $h_1$ ) of frustum part =  $22 - 10 = 12 \text{ cm}$

Height ( $h_2$ ) of cylindrical part =  $10 \text{ cm}$

Slant height ( $l$ ) of frustum part =  $\sqrt{(r_1 - r_2)^2 + h^2} = \sqrt{(9 - 4)^2 + (12)^2} = 13 \text{ cm}$

Area of tin sheet required = CSA of frustum part + CSA of cylindrical part

$$= \pi(r_1 + r_2)l + 2\pi r_2 h_2$$

$$= \frac{22}{7} \times (9 + 4) \times 13 + 2 \times \frac{22}{7} \times 4 \times 10$$

$$= \frac{22}{7} [169 + 80] = \frac{22 \times 249}{7}$$

$$= 782 \frac{4}{7} \text{ cm}^2$$

### Question 6:

Derive the formula for the curved surface area and total surface area of the frustum of cone.

Answer:



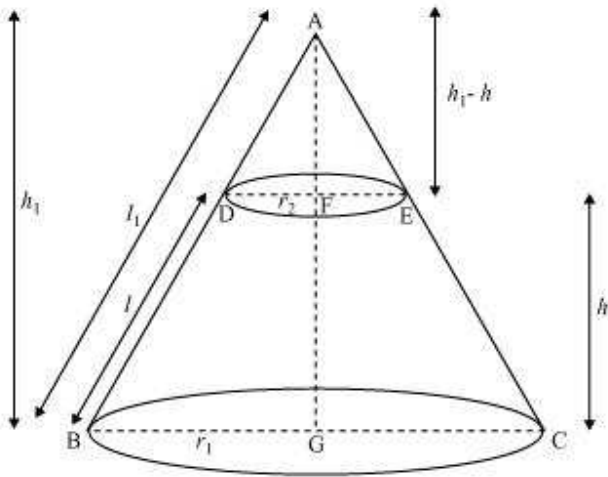

Let ABC be a cone. A frustum DECB is cut by a plane parallel to its base. Let  $r_1$  and  $r_2$  be the radii of the ends of the frustum of the cone and  $h$  be the height of the frustum of the cone.

In  $\triangle ABG$  and  $\triangle ADF$ ,  $DF \parallel BG$

$\therefore \triangle ABG \sim \triangle ADF$

$$\frac{DF}{BG} = \frac{AF}{AG} = \frac{AD}{AB}$$

$$\frac{r_2}{r_1} = \frac{h_1 - h}{h_1} = \frac{l_1 - l}{l_1}$$

$$\frac{r_2}{r_1} = 1 - \frac{h}{h_1} = 1 - \frac{l}{l_1}$$

$$1 - \frac{l}{l_1} = \frac{r_2}{r_1}$$

$$\frac{l}{l_1} = 1 - \frac{r_2}{r_1} = \frac{r_1 - r_2}{r_1}$$

$$\frac{l_1}{l} = \frac{r_1}{r_1 - r_2}$$

$$l_1 = \frac{r_1 l}{r_1 - r_2}$$

CSA of frustum DECB = CSA of cone ABC – CSA cone ADE

$$\begin{aligned} &= \pi r_1 l_1 - \pi r_2 (l_1 - l) \\ &= \pi r_1 \left( \frac{l r_1}{r_1 - r_2} \right) - \pi r_2 \left[ \frac{r_1 l}{r_1 - r_2} - l \right] \\ &= \frac{\pi r_1^2 l}{r_1 - r_2} - \pi r_2 \left( \frac{r_1 l - r_1 l + r_2 l}{r_1 - r_2} \right) \\ &= \frac{\pi r_1^2 l}{r_1 - r_2} - \frac{\pi r_2^2 l}{r_1 - r_2} \\ &= \pi l \left[ \frac{r_1^2 - r_2^2}{r_1 - r_2} \right] \end{aligned}$$

$$\text{CSA of frustum} = \pi (r_1 + r_2) l$$

Total surface area of frustum = CSA of frustum + Area of upper circular end  
+ Area of lower circular end

$$\begin{aligned} &= \pi (r_1 + r_2) l + \pi r_2^2 + \pi r_1^2 \\ &= \pi \left[ (r_1 + r_2) l + r_1^2 + r_2^2 \right] \end{aligned}$$

### Question 7:

Derive the formula for the volume of the frustum of a cone.

Answer:

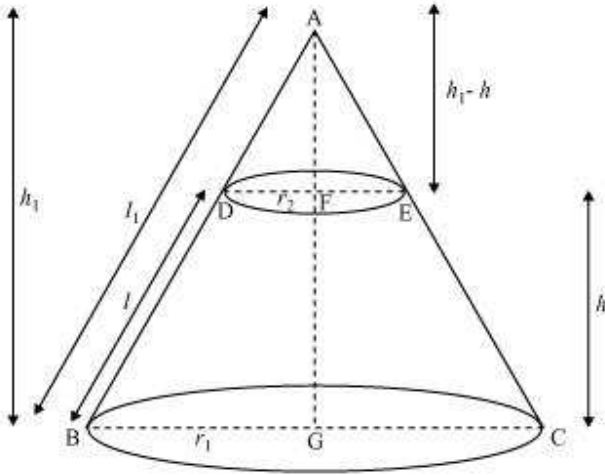

Let ABC be a cone. A frustum DECB is cut by a plane parallel to its base.

Let  $r_1$  and  $r_2$  be the radii of the ends of the frustum of the cone and  $h$  be the height of the frustum of the cone.

In  $\triangle ABG$  and  $\triangle ADF$ ,  $DF \parallel BG$

$\therefore \triangle ABG \sim \triangle ADF$

$$\frac{DF}{BG} = \frac{AF}{AG} = \frac{AD}{AB}$$

$$\frac{r_2}{r_1} = \frac{h_1 - h}{h_1} = \frac{l_1 - l}{l_1}$$

$$\frac{r_2}{r_1} = 1 - \frac{h}{h_1} = 1 - \frac{l}{l_1}$$

$$1 - \frac{h}{h_1} = \frac{r_2}{r_1}$$

$$\frac{h}{h_1} = 1 - \frac{r_2}{r_1} = \frac{r_1 - r_2}{r_1}$$

$$\frac{h_1}{h} = \frac{r_1}{r_1 - r_2}$$

$$h_1 = \frac{r_1 h}{r_1 - r_2}$$

Volume of frustum of cone = Volume of cone ABC – Volume of cone ADE

$$= \frac{1}{3} \pi r_1^2 h_1 - \frac{1}{3} \pi r_2^2 (h_1 - h)$$

$$= \frac{\pi}{3} [r_1^2 h_1 - r_2^2 (h_1 - h)]$$

$$= \frac{\pi}{3} \left[ r_1^2 \left( \frac{hr_1}{r_1 - r_2} \right) - r_2^2 \left( \frac{hr_1}{r_1 - r_2} - h \right) \right]$$

$$= \frac{\pi}{3} \left[ \left( \frac{hr_1^3}{r_1 - r_2} \right) - r_2^2 \left( \frac{hr_1 - hr_1 + hr_2}{r_1 - r_2} \right) \right]$$

$$= \frac{\pi}{3} \left[ \frac{hr_1^3}{r_1 - r_2} - \frac{hr_2^3}{r_1 - r_2} \right]$$

$$= \frac{\pi}{3} h \left[ \frac{r_1^3 - r_2^3}{r_1 - r_2} \right]$$

$$= \frac{\pi}{3} h \left[ \frac{(r_1 - r_2)(r_1^2 + r_2^2 + r_1 r_2)}{r_1 - r_2} \right]$$

$$= \frac{1}{3} \pi h [r_1^2 + r_2^2 + r_1 r_2]$$