

ELECTROCHEMISTRY

SECTION I

Electrolytes

Solids and liquid substances, which are able to conduct the electric current, can be divided in two categories i.e. metallic conductors and electrolytic conductors

In metallic conductors or electronic conductors, the electric current is carried by the free electrons. When an electric potential is applied to metallic conductors, the electrons start to move in one direction while positive ions remains stationary. Thus the flow of electrons is no accompanied by appreciable movement of the matter

Electrolytic conductors or electrolytes are distinguished from metallic conductors by the fact that the current is carried by ions and not by electrons. The application of an electric potential causes these charged particles of matter to move, the positive ions move towards the cathode and the negative ions move towards anode. Thus, passage of an electric current is accompanied by the transfer of matter. This transfer is manifested by change in concentration and also by visible separation of material at the points where the electric charge enters and leaves the electrolyte. Electrolytes generally employed are salts in molten form or are dissolved in water

Sr	Electronic conduction	Electrolytic conduction
1	Pure metal and their solution as alloys are called as metallic conductors	Ionic compound conduct electricity in molten state or in solution due to movement of ions
2	Free mobile electrons of metallic atom or alloys are responsible for conduction	Ions with positive charge move towards cathode while negative charge move towards anode
3	Positive holes in the metal moves in opposite to the direction of electrons in case of semiconductors	Electrolysis occur when current pass through ionic solution
4	There is no chemical change in the material when electricity is passed.	Chemical change occurs
5	There is only flow of energy but no transfer of matter	There is actual transfer of matter since ions move to electrodes
6	Conductivity of metals decreases with increase in temperature due to enhanced vibration of metal ions disrupting movement of electrons	With increase in temperature conductivity increases due to increased mobility of ions

Electrolysis

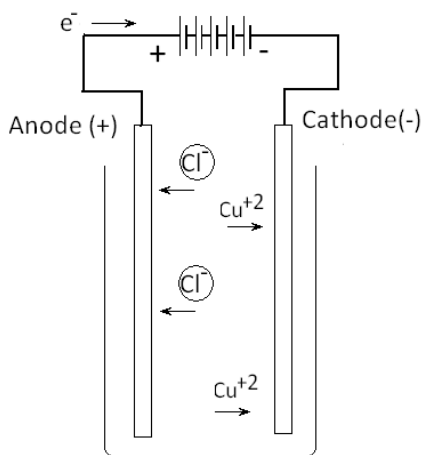

Take two rods of suitable metals called as electrodes, which are immersed in electrolytic solution (Water soluble salt of metals) g.g. CuCl_2 . The rods are now connected to a source of e.m.f (battery) The electrode through which electron enters in the cell is called the negative electrode or cathode while that at which electrons leave is known as the positive electrode or anode. The cations carry positive charge while anion carry negative charge.

As soon as the electrodes are connected to battery, the cations Cu^{+2} starts moving towards cathode, take up electrons from rod and get reduced to deposit as metal (Cu) while anions (Cl^-) move towards anode and get

oxidized to release Cl_2 gas.

Thus at anode , oxidation takes place while at cathode reduction takes place

The reaction at the two electrodes are

At cathode $\text{Cu}^{+2} + 2\text{e}^- \rightarrow \text{Cu}$

At anode $2\text{Cl}^- \rightarrow \text{Cl}_2 + 2\text{e}^-$

Electrolysis is the process of chemical decomposition of the electrolyte by the passage of electric current. It is carried out in a cell called electrolytic cell.

Electrolytic cell convert electrical energy into chemical energy.

Faraday's laws of electrolysis

Faraday established the relationship between the quantity of electricity passes through electrolyte and the amount of material liberated or deposited at the electrode.

First law of electrolysis

The amount of any substance deposited or dissolved at a particular electrode is proportional to the quantity of electricity utilized. $m \propto Q$

$M = Z$ it as $Q = It$

Here m is the mass of substance deposited Q is the amount of charge utilized in Coulombs, I is the current in Ampere and t is time in seconds and Z is electrochemical equivalent

Remember that Q is the amount of charge utilized not charge passing

Electrochemical equivalent is the mass of substance deposited in gram either by passing one coulomb of charge or by passing one ampere of current for one second.

One faraday is the quantity of charge carried by one mole of electrons

$\therefore 1 \text{ F} = 1.6 \times 10^{-19} \times 6.023 \times 10^{23} = 96500 \text{ coulombs}$

Or One Faraday is the quantity of charge which must be passed in order to deposited or dissolved one gram equivalent of any substance

Let E be the equivalent mass of substance deposited at any electrode. Since 96500 coulombs of charge is required to deposit E grams of substance, therefore one coulomb charge would deposit $(E/96500)$ grams, which is the electrochemical equivalent (Z) of the substance. $Z = (E/96500)$

Second law of electrolysis

The amounts of different substances deposited or dissolved by the same quantity of electricity are proportional to their respective chemical equivalent weights.

From first law

$$m = \frac{EIt}{96500}$$

Rearranging the terms we get

$$\frac{m}{Z} = \frac{It}{96500} = \frac{Q}{96500} = \text{Number of equivalents}$$

$$\frac{m}{Z} = \text{constant}$$

Or

$$\frac{m}{E} = \text{constant}$$

As charge utilized is same

Note equivalent mass $E = M/p$ Here M is atomic mass and p is valency

This means that if the quantity of charge passed through electrolytic cells connected in series is same, the equivalents of substances deposited at various electrodes would be same.

For example, consider the given reactions at two different cathodes in two different electrolytic cells connected in series.

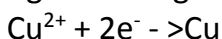
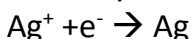

Let us assume x mole of electrons is passed through both the cells

Mole of Ag deposited = x

Equivalent of Ag deposited = $x \times 1 = x$

Mole of Cu deposited = $x/2$

Equivalent of Cu deposited = $(x/2) \times 2 = x$

Thus, it is evident that the equivalents of both metals (Ag & Cu) deposited are same (i.e. x). The Faraday's laws are universally accepted laws, applicable at all temperatures, for non-aqueous, aqueous solutions and fused electrolytes and whether the electrode reaction leads to metal depositions or not.

Solved Numerical

If 50 milli ampere of current is passed through copper coulometer for 60 min, calculate the amount of copper deposited.

Solution : Electrical charge input = $I \times t$ coulombs

$$= 50 \times 10^{-3} \times 60 \times 60 \text{ sec}$$

$$= 180 \text{ coulombs.}$$

The chemical reaction is, $\text{Cu}^{2+} + 2\text{e}^- \rightarrow \text{Cu(s)}$

1 mole of copper requires 2F current

$$\therefore \text{amount copper deposited} = \frac{63.5 \times 180}{2 \times 96500}$$

Amount of copper deposited = 0.0592 gm.

Q) An electric current is passed through three cells in series containing respectively solutions of copper sulphate, silver nitrate and potassium iodide. What weights of silver and iodine will be liberated while 1.25 g of copper is being deposited ?

Solution

$$\frac{\text{weight of copper}}{\text{weight of Iodine}} = \frac{\text{Equivalent wt of copper}}{\text{Equivalent wt of Iodine}}$$

$$\frac{1.25}{x} = \frac{31.7}{127}$$

Weight of Iodine x = 0.5 g

Also

$$\frac{\text{weight of copper}}{\text{weight of silver}} = \frac{\text{Equivalent wt of copper}}{\text{Equivalent wt of Silver}}$$

$$\frac{1.25}{y} = \frac{31.7}{108}$$

Weight of silver y = 4.26 g

Electrolytic conductance

Molten electrolytes and the aqueous solutions of electrolytes contains free ions and conducts electricity due to the movement of ions

We know that Ohm's law is applicable to metallic conductors but it is also valid for electrolytic conductors. According to the Ohm's law, the resistance of a conductor is directly proportional to the length and is inversely proportional to cross-sectional area

Now consider a electrolyte cell in which electrodes are separated by distance 'l' and surface area is 'a.' Then resistance of the electrolyte enclosed by the electrodes is

$$R = \rho \frac{l}{a}$$

Now if l = 1 unit and a = 1 unit the R = ρ

ρ is the resistivity of the solution held between the electrodes unit is ohm×m in SI unit

Conductivity of solutions

$$\text{Conductance (G)} = \frac{1}{\text{Resistance(R)}}$$

$$G = \frac{1}{R}$$

SI unit is ohm⁻¹ or mho. Is now a days called Siemens (S). Therefore 1 ohm⁻¹ = 1S

$$G = \frac{1}{\rho} \frac{a}{l} = k \frac{a}{l}$$

Where k is called conductivity of the solution or specific conductance. This gives

$$k = G \times \frac{l}{a}$$

l/a is called cell constant

$$k = \text{Conductance} \times \text{cell constant}$$

If $l = 1$ and $a=1$ then

$$K = G$$

Thus, the conductivity may be defined as the conductance of any solution held between two electrodes of one unit area and separated by a distance of one unit.

The unit of conductivity depends upon the unit in which the quantities G , l and a are measured.

In SI system $k = \text{Sm}^{-1}$ (Siemens/metre) In CGS system S cm^{-1}

Equivalent conductivity

The equivalent conductivity (Λ_{eq}) of an electrolyte in solution may be defined as "The conducting power of all ions furnished by one equivalent of an electrolyte in any solution is termed as its equivalent conductivity"

Equivalent conductivity is expressed as

$$\text{Equivalent conductivity } (\Lambda_{\text{eq}}) = \frac{\text{conductivity } (k)}{\text{Concentration in equivalents per unit volume } (C_{\text{eq}})}$$

$$\Lambda_{\text{eq}} = \frac{k}{C_{\text{eq}}}$$

Units of Λ_{eq} depends on the units of k and C_{eq}

If the conductivity is measured in Scm^{-1} and concentration in **Normality** the expression of Λ_{eq} becomes

$$\Lambda_{\text{eq}} = \frac{k}{C_{\text{eq}}} \frac{(\text{Scm}^{-1})}{(\text{equivalent wt} \times L^{-1})}$$

But 1 litre = 1dm = 10^3 cm thus

$$\Lambda_{\text{eq}} = \frac{k}{C_{\text{eq}}} \frac{(\text{Scm}^{-1} \times 10^3 \times \text{cm}^3)}{(\text{equivalent wt})}$$

$$\Lambda_{\text{eq}} = \frac{1000k}{C_{\text{eq}}} (\text{Scm}^2 \text{equiv}^{-1})$$

$$\Lambda_{\text{eq}} = \frac{1000k}{\text{Normality}} (\text{Scm}^2 \text{equiv}^{-1})$$

Molar conductivity

The conducting power of a solution can also be described in terms of molar conductivity (Λ_m) may be defined as

"The conducting power of all the ions furnished by one mole of an electrolyte in the solution is termed as its molar conductivity"

Thus

$$\text{Molar conductivity } (\Lambda_m) = \frac{\text{conductivity } (k)}{\text{Concentration in equivalents per unit volume } (C_m)}$$

$$\Lambda_m = \frac{k}{C_m}$$

Units of Λ_m depends on the the units of conductivity and concentration

When the conductivity is measured in $S\text{cm}^{-1}$ and concentration is measured in mole/litre then the expression of Λ_m becomes

$$\Lambda_m = \frac{k}{C_m} \frac{(S\text{cm}^{-1})}{(\text{mol} \times L^{-1})}$$

But 1 litre = 1dm = 10^3 cm thus

$$\Lambda_m = \frac{k}{C_m} \frac{(S\text{cm}^{-1} \times 10^3 \times \text{cm}^3)}{(\text{mol})}$$

$$\Lambda_m = \frac{1000k}{C_m} (S\text{cm}^2\text{mol}^{-1})$$

$$\Lambda_m = \frac{1000k}{\text{Molarity of the solution}} (S\text{cm}^2\text{mol}^{-1})$$

Molar conductivity increases with decrease in concentration. This is because the total volume, V , of solution containing one mole of electrolyte also increases. It has been found that decrease in k on dilution of a solution is more than compensated by increase in its volume. .

Solved Numerical

Q) The resistance of a 0.01 N solution of an electrolyte was found to 210 ohm at 25°C using a conductance cell with a cell constant 0.88 cm^{-1} . Calculate the specific conductance and equivalent conductance of the solution.

Solution

$$R = 210 \text{ ohm}, l/a = 0.88 \text{ cm}^{-1}$$

Specific conductance

$$k = \frac{l}{a} \times \frac{1}{R}$$

$$k = \frac{0.88}{210} = 4.19 \times 10^{-3} \text{ mho cm}^{-1}$$

$$\Lambda_{\text{eq}} = \frac{1000k}{\text{Normality}} (S\text{cm}^2\text{equiv}^{-1})$$

$$\Lambda_{\text{eq}} = \frac{1000 \times 4.19 \times 10^{-3}}{0.01} (S\text{cm}^2\text{equiv}^{-1})$$

$$\Lambda_{eq} = 419 \text{ S cm}^2 \text{ equiv}^{-1}$$

Relationship between molar and equivalent conductivities

According to the definition

$$\Lambda_m = \frac{k}{C_m}$$

And

$$\Lambda_{eq} = \frac{k}{C_{eq}}$$

For a solution containing a certain mass of the solute per unit volume of the solution (let us say 'w' gram per litre) we can write

$$C_m = \frac{w}{\text{molar mass of the electrolyte}}$$

And

$$C_{eq} = \frac{w}{\text{equivalent mass of the electrolyte}}$$

From these relations, we can write

$$\frac{C_m}{C_{eq}} = \frac{\text{Equivalent mass of the electrolyte}}{\text{Molar mass of the electrolyte}}$$

We know that molar mass of an electrolyte = $z \times$ Equivalent mass of the electrolyte
Where z is the charge on per metal ions of electrolyte.

$$\frac{C_m}{C_{eq}} = \frac{1}{z}$$

Kohlrausch's law

This law states that, "at infinite dilution wherein the ionisation of all electrolytes is complete, each ion migrates independently and contributes a definite value to the total equivalent conductance of the electrolyte". Consider an electrolyte AB in aqueous solution. It dissociates as



Then at infinite dilution, according to Kohlrausch's law, the total equivalent conductance of the electrolyte.

$$\lambda_{\infty} = \frac{1}{n^+} \lambda_A^+ + \frac{1}{m^-} \lambda_B^-$$

where λ_A^+ and λ_B^- are the cationic and anionic equivalent conductances at infinite dilutions and n^+ and m^- correspond the valency of cations and anions furnished from each molecule of the electrolyte.

For infinite dilution

$$\lambda_{\infty}, \text{NaCl} = \lambda_{\infty}^+ \text{Na}^+ + \lambda_{\infty}^- \text{Cl}^-$$

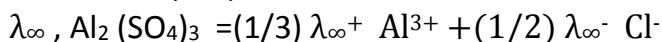
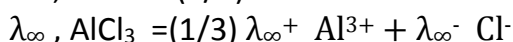
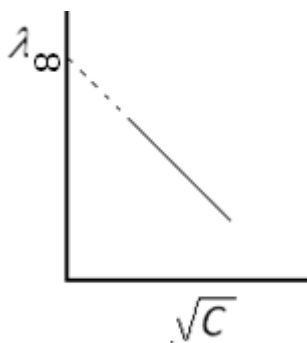

The molar conductivity of strong electrolyte at infinite dilution can be determined by extrapolation of graph of equivalent conductivity vs concentration

For weak electrolytes,

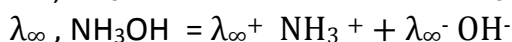
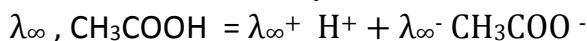

The molar conductivity of a weak electrolyte at infinite dilution (λ_{∞}) can not be determined by extrapolation method. But λ_{∞} can be determined by Kohlrausch's equation. λ_{∞} of CH_3COOH which is a weak electrolyte is deduced from λ_{∞} values of NaCl , HCl , and CH_3COONa in such a manner that λ_{∞} of CH_3COOH is obtained. Sodium acetate (CH_3COONa) is a strong electrolyte and it ionises to acetate (CH_3COO^-) and sodium (Na^+) ions at all concentrations in water. Applying Kohlrausch's law,

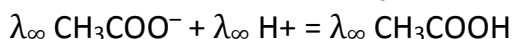

This method produces agreeable values of λ_{∞} for weak electrolytes

Similarly $\lambda_{\infty}\text{NH}_4\text{OH}$ can be deduced as,

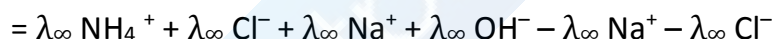
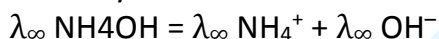

In case of weak electrolytes, degree of dissociation (α) increases when concentration decreases. Hence, $(1 - \alpha)$ value tends to zero at infinite dilution, such that λ_{eq} increases and tends to λ_{∞} value.

λ_{∞} of weak electrolytes are experimentally obtained by extrapolating the upper arm of the curve to the Y axis and the intercept value corresponds to λ_{∞} . In the intermediate concentration range, λ_{eq} is lower than λ_{∞} since the weak electrolyte exists in partially ionised state. The degree of dissociation

α equals to the ratio of λ_{eq} to λ_{∞} value. (i.e., $\alpha = \lambda_{\text{eq}} / \lambda_{\infty}$).

Solved numerical

Q) 0.04 N solution of a weak acid has a specific conductance $4.23 \times 10^{-4} \text{ S.cm}^{-1}$. The degree of dissociation of acid at this dilution is 0.0612. Calculate the equivalent conductance of weak acid at infinite dilution

Solution

Specific conductance $k = 4.23 \times 10^{-4} \text{ mho.cm}^{-1}$

$$\Lambda_{\text{eq}} = \frac{1000k}{\text{Normality}} (\text{Scm}^2\text{equiv}^{-1})$$

$$\Lambda_{eq} = \frac{1000 \times 4.23 \times 10^{-4}}{0.04} = 10.575 (\text{Scm}^2 \text{equiv}^{-1})$$

$$\alpha = \frac{\Lambda_{eq}}{\Lambda_{\infty}}$$

$$0.0612 = \frac{10.575}{\Lambda_{\infty}}$$

$$\Lambda_{\infty} = 172.79 \text{ S.cm}^2.\text{equiv}^{-1}$$

Q) Equivalent conductivity of acetic acid at infinite dilution is 390.7 and for 0.1 M acetic acid the equivalent conductance is 5.2 mho.cm². equiv⁻¹. Calculate degree of dissociation, H⁺ ion concentration and dissociation constant of the acid.

Solution

$$\alpha = \frac{\Lambda_{eq}}{\Lambda_{\infty}} = \frac{5.2}{390.7} = 0.01333$$

$$\alpha = 1.33\%$$

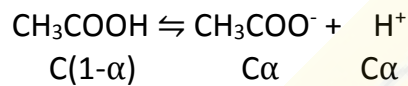

$$\therefore [\text{H}^+] = \text{C}\alpha = 0.1 \times 0.01333 = 0.00133 \text{ M}$$

Q) Ionic conductances at infinite dilution of Al³⁺ and SO₄²⁻ are 189 ohm⁻¹ cm² equiv⁻¹ and 160 ohm⁻¹ cm² equiv⁻¹. Calculate equivalent and molar conductance of the electrolyte at infinite dilution of electrolytes Al₂(SO₄)₃

Solution

$$\lambda_{\infty} = \frac{1}{n^+} \lambda_A^+ + \frac{1}{m^-} \lambda_B^-$$

$$\lambda_{\infty} = \frac{1}{3} \times 189 + \frac{1}{2} \times 160 = 143 \text{ Scm}^2 \text{equiv}^{-1}$$

SECTION II

Electrochemical cell

When a strip of Zinc is dipped in CuSO_4 , we start to see that Zn strip starts to dissolved in CuSO_4 and Cu starts to deposit on the surface.

This happens because Zn is oxidized to Zn^{2+} which passes into the solution and two electrons remains on the Zn rod taken up by Cu^{+2} ions from solution to is reduced to Cu. In this reaction, Zn acts as reducing agent, which is able to reduce Cu^{2+} to Cu by transfer of 2 electrons and Cu^{2+} ions acts as an oxidizing agent, which oxidizes Zn to Zn^{2+} ions and itself gets reduced to Cu. In this case there is a direct transfer of electrons from Zn rod to Cu^{2+} ions and some heat is also evolved

The above experiment is slightly modified in a manner that for the same redox reaction transfer of electrons takes place indirectly and the heat of the reaction is converted into electrical energy.

This necessities that separation of Zn rod from CuSO_4 solution. Such cells in which the oxidised and reduced species are separated and connected through electric wires are called electro-chemical cells.

Electrochemical cells are the cells in which chemical energy is transformed into electrical energy. This means that chemical reactions produce electric current.

An electrochemical cell consists of two half-cells or electrodes. The electrodes are metallic conductors dipped in an electrolyte, which is an ionic conductor dissolved in water. A metallic rod and its electrolyte comprises an electrode or half cell compartment. The two electrodes may share the same or different electrolyte. The various electrodes used are

- (i) Metal –metal ion electrode
- (ii) Gas-gas ion electrode
- (iii) (ii) Redox electrode
- (iv) Metal-insoluble metal salt-anion electrodes

The simplest electrochemical cell to study is Daniel cell ,

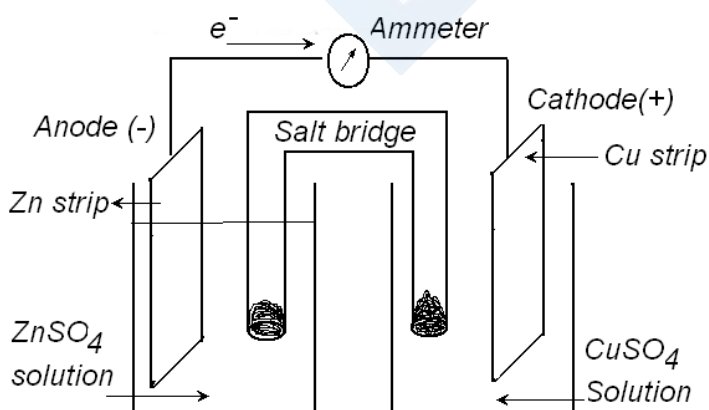

it is prepared by dipping Zn rod in ZnSO_4 solution in one beaker and Cu strip is dipped in another beaker containing CuSO_4

Since Zinc is more reactive than copper, so it has higher tendency to get oxidized than Cu. At this stage no reaction takes place in any beaker. Now when both the electrodes are connected with each other through a

ammeter by conducting wire, Zn start to dissolve in ZnSO_4 i.e. Zn atom changes to Zn^{2+} by losing 2 electrons, there by increases Zn^{2+} concentration in solution. Electron remains on Zn rod there by there is a charge separation of 4 units between Zn rod and ZnSO_4 solution.

The zinc rod which has the electron left becomes negatively charged while Cu rod which lost electrons to Cu^{2+} becomes positively charged.

Thus electric current flows through the connected wire, which is indicated by the deflection in ammeter showing that a chemical reaction is occurring in the cell.

During the process weight of zinc rod get reduced while weight of copper rod increases.

Thus the Concentration of CuSO_4 decreases while concentration of Zn^{2+} increases.

Since Oxidation reaction takes place at Zn strip is called Anode which is the negatively charged electrode

While reduction reaction takes place at Cu is called cathode, is positively charged electrode.

The flow of electron takes place from Anode to cathode through external circuit or connecting wire while indirectly from cathode to anode inside the cell

As we have seen that Zn^{2+} ions concentration goes on increasing in solution at a particular concentration of Zn^{2+} further oxidation of Zn will be prevented by the Zn^{2+} ions present in the solution thus it will stop the working of cell.

We could maintain the neutrality of solutions we could get continuous flow of current.

This can be achieved by using salt bridge. The salt bridge contains a highly soluble electrolytes (like KCl, NH_4NO_3 , NH_4Cl , KNO_3) in which ionic mobility of cation and anion are of comparable order

Since zinc ions are produced as electrons leaves the zinc electrode, this tends to produce a net positive charge into the solution to neutralize the charge the salt bridge then throws anions having equivalent charge into the solution to maintain electrical neutrality.

Thus salt bridge maintains the neutrality in both the half

Salt bridge do not participate chemically in the cell reaction but it is essential to cell to operate continuously

Cell notation of an electrochemical cell

- (i) Anode is written on the left side and cathode is written on the right side
- (ii) Phase boundaries are indicated by vertical bar or slash
- (iii) Concentration of the electrolytes in the anode and cathode must be written in parenthesis
- (iv) In case of gas, the partial pressure is to be mentioned in atm or mm Hg
- (v) A comma is used to separate two chemical species present in the same solution
- (vi) A double vertical line i.e || denotes that a salt bridge is present
- (vii) EMF of the cell is written on the extreme right of the representation

For examples

- (i) $\text{Zn(s)}|\text{ZnSO}_4(\text{C}_1\text{M})||\text{CuSO}_4(\text{C}_2\text{M})|\text{Cu(s)}; E_{\text{cell}}$
- (ii) $\text{Pt}|\text{H}_2(\text{P}_1 \text{ atm})|\text{HCl}(\text{cM})|\text{AgCl(s)}|\text{Ag}; E_{\text{cell}}$
- (iii) $\text{Pt}|\text{Fe}^{2+}(\text{C}_1\text{M}),\text{Fe}^{3+}(\text{C}_2\text{M})||\text{Ag}^+(\text{cM})|\text{Ag}; E_{\text{cell}}$

In cell representation as in (ii) the salt bridge is not indicated which implies that the electrolyte is common to both anode and cathode compartments

Single electrode potential

An electrochemical cell consists of two half-cells. With an open-circuit, the metal electrode in each half-cell transfers its ions into solution.

Thus an individual electrode develops a potential with respect to the solution. The potential of a single electrode in a half-cell is called the **Single electrode potential**.

Thus in Daniel cell in which the electrodes are not connected externally, the anode Zn/Zn^{2+} develops a negative charge and the cathode Cu/Cu^{2+} , a positive charge.

The amount of the charge produced on an individual electrode determines its single electrode potential. The single electrode potential of a half-cell depends on : (a) concentration of ions in solution ; (b) tendency to form ions ; and (c) temperature.

Standard emf of a cell

The emf generated by an electrochemical cell is given by the symbol E .

It can be measured with the help of a potentiometer. The value of emf varies with the concentration of the anode and cathode solutions and the temperature of the cell. When the emf of a cell is determined under standard conditions, it is called the standard emf.

The standard conditions are :

- (a) 1 M solutions of anode and cathode
- (b) temperature of 25°C .

Thus standard emf may be defined as the emf of a cell with 1 M solutions of reactants and products in solution measured at 25°C . Standard emf of a cell is represented by the symbol E° . For gases 1 atm. pressure is a standard condition instead of concentration. For Zn-Cu voltaic cell, the standard emf, E° is 1.10V.

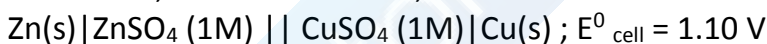

Standard Hydrogen Electrode (SHE)

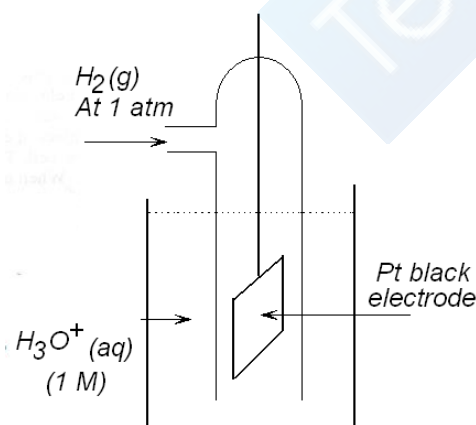

The standard hydrogen half-cell or Standard Hydrogen Electrode (SHE), is selected for coupling with the unknown half-cell. It consists of a platinum electrode immersed in a 1 M solution of H^+ ions maintained at 25°C .

Hydrogen gas at one atmosphere enters the glass hood and bubbles over the platinum electrode. The hydrogen gas at the platinum electrode passes into solution, forming H^+ ions and electrons.

The emf of the standard hydrogen electrode is arbitrarily assigned the value of zero volts.

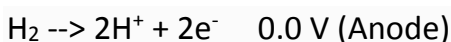

So, SHE can be used as a standard for other electrodes.

The half-cell whose potential is desired, is combined with the hydrogen electrode and the emf of the complete cell determined with a voltmeter. The emf of the cell is the emf of the half-cell.

For example, it is desired to determine the emf of the zinc electrode, $\text{Zn} | \text{Zn}^{2+}$. It is connected with the SHE. The complete electrochemical cell may be represented as :

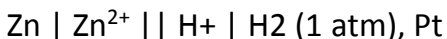

Since SHE is used as cathode we get oxidation potential of Zn which found to be

Electrode potential

Depending on the nature of the metal electrode to lose or gain electrons, the electrode potential may be of two types:

(i) Oxidation potential:

When electrode is negatively charged with respect to solution, i.e., it acts as anode. Oxidation occurs.



(ii) Reduction potential:

When electrode is positively charged with respect to solution, i.e., it acts as cathode. Reduction occurs.



It is not possible to measure the absolute value of the single electrode potential directly. Only the difference in potential between two electrodes can be measured experimentally. It is, therefore, necessary to couple the electrode with another electrode whose potential is known. This electrode is termed as **reference electrode**. The emf of the resulting cell is measured experimentally. The emf of the cell is equal to the sum of potentials on the two electrodes.

Emf of the cell = Oxidation potential of anode - Oxidation potential of cathode

OR

Emf of the cell = Reduction potential of Cathode - Reduction potential of Anode

OR

Emf of the cell = Oxidation potential of anode + Reduction potential of cathode

Knowing the value of reference electrode in case of SHE it is zero, the value of other electrode can be determined.

Note that Oxidation potential = - reduction potential

SOLVED NUMERICAL

Q) Calculate the standard e.m.f. of the cell : $\text{Cd} | \text{Cd}^{2+} || \text{Cu}^{2+} | \text{Cu}$ and determine the cell reaction. The standard reduction potentials of $\text{Cu}^{2+} | \text{Cu}$ and $\text{Cd}^{2+} | \text{Cd}$ are 0.34V and -0.40 volts respectively. Predict the feasibility of the cell reaction.

Solution:

Cell reaction is



Here $\text{Cd}|\text{Cd}^{2+}$ is anode = -0.40V while $\text{Cu}^{2+}|\text{Cu}$ is cathode = 0.34V

Since reduction potential are given

Emf of the cell = Reduction potential of Cathode - Reduction potential of Anode

$$\text{Emf of the cell} = 0.34 - (-0.40) = 0.74 \text{ V}$$

Since cell potential is positive, reaction is feasible

Q) Determine the standard emf of the cell and predict its feasibility.

$\text{Ag}|\text{Ag}^+||\text{H}^+|\text{H}_2(\text{g})1\text{atm}, \text{Pt}$.

Solution:

The standard reduction potential of $\text{Ag}^+|\text{Ag}$ is 0.80 volts which is positive thus Ag acts as cathode

The right hand side electrode is SHE.

$$E_{\text{cell}} = [\text{Std. reduction potential of SHE}] - [\text{Std. reduction potential of Ag}^+|\text{Ag}] \\ = 0 - (+0.8 \text{ V}) = -0.8 \text{ Volts.}$$

Since E°_{cell} is negative, the cell reaction is not feasible.

Relation between EMF and free energy

When a cell produces a current, the current can be used to do work – to run a motor, for instance. Thermodynamic principles can be employed to derive a relation between electrical energy and the maximum amount of work, W_{max} , obtainable from the cell. The maximum amount of work obtainable from the cell is the product of charge flowing per mole and maximum potential difference, E , through which the charge is transferred.

$$W_{\text{max}} = -nFE \dots (1)$$

where n is the number of moles of electrons transferred and is equal to the valence of the ion participating in the cell reaction. F stands for Faraday and is equal to 96,500 coulombs and E is the emf of the cell.

According to thermodynamics, the maximum work that can be derived from a chemical reaction is equal to the free energy (ΔG) for the reaction,

$$W_{\text{max}} = \Delta G \dots (2)$$

Therefore, from (1) and (2), we can write

$$\Delta G = -nFE \dots (3)$$

Thus only when E has a positive value, ΔG value will be negative and the cell reaction will be spontaneous and the e.m.f. of the cell can be measured.

Here E refers to the E_{cell} .

Thus, the electrical energy supplied by the cell is (nFE) equal to the free energy decrease ($-\Delta G$) of the cell reaction occurring in the cell.

Q) Determine the standard emf of the cell and standard free energy change of the cell reaction. $\text{Zn}|\text{Zn}^{2+}||\text{Ni}^{2+}|\text{Ni}$. The standard reduction potentials of $\text{Zn}^{2+}|\text{Zn}$ and $\text{Ni}^{2+}|\text{Ni}$ half cells are - 0.76 V and - 0.25 V respectively.

Solution:

Cell reaction

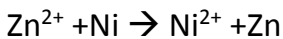

Here Zn | Zn²⁺ = -0.76 V is anode Ni²⁺ | Ni = -0.25V is cathode

Emf of the cell = Reduction potential of Cathode - Reduction potential of Anode

$$\text{Emf of the cell} = -0.2 - 0.76 = 0.51\text{V}$$

$$\Delta G = -nFE$$

$$N = 2$$

$$\Delta G = -2 \times 96500 \times 0.51 = -97460 \text{ Joules} = -97.46 \text{ kJ}$$

ΔG is negative thus reaction is spontaneous

Cell potential and Nernst equation

Nernst equation is used to relate either half-cell potential or EMF of a cell with concentration of the involved species..

Consider a redox reaction of cell

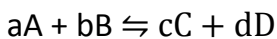

Where A, B, C, D are the species whose concentration vary. i.e they are either gases or solution species. For species A, the free energy per mole of A can be given thermodynamically as

$$G_A = G_A^{\circ} + RT \ln [A]$$

For a moles of A

$$aG_A = aG_A^{\circ} + aRT \ln [A] = aG_A^{\circ} + RT \ln [A]^a$$

Similarly for other species

$$bG_B = bG_B^{\circ} + RT \ln [B]^b$$

$$cG_C = cG_C^{\circ} + RT \ln [C]^c$$

$$dG_D = dG_D^{\circ} + RT \ln [D]^d$$

Now, the free energy changes for the overall cell reaction can be deduced as

$$\Delta G = (cG_C + dG_D) - (aG_A + bG_B)$$

$$= (cG_B^{\circ} + RT \ln [C]^c + dG_D^{\circ} + RT \ln [D]^d) - (aG_A^{\circ} + RT \ln [A]^a + bG_B^{\circ} + RT \ln [B]^b)$$

$$= cG_B^{\circ} + dG_D^{\circ} - (aG_A^{\circ} + bG_B^{\circ}) + (RT \ln [C]^c + RT \ln [D]^d - RT \ln [A]^a - RT \ln [B]^b)$$

$$\Delta G = \Delta G^{\circ} + RT \ln \frac{[C]^c [D]^d}{[A]^a [B]^b}$$

Where ΔG° is the free energy change when all the reactants and products are present at one molar concentration

From the relation between free energy and cell potential

$$-nFE_{cell} = -nFE_{cell}^{\circ} + RT \ln \frac{[C]^c [D]^d}{[A]^a [B]^b}$$

Dividing both sides by $-nF$ gives

$$E_{cell} = E_{cell}^{\circ} - \frac{RT}{nF} \ln \frac{[C]^c [D]^d}{[A]^a [B]^b}$$

Putting $T = 398\text{K}$, $R = 8.314 \text{ J/mol}$, $F = 96500\text{C}$ we get

$$E_{cell} = E_{cell}^{\circ} - \frac{0.059}{n} \log \frac{[C]^c [D]^d}{[A]^a [B]^b}$$

SOLVED NUMERICAL

Q) What is the potential of a half-cell consisting of zinc electrode in 0.01 M ZnSO₄ solution 25°C. $E^\circ = 0.763$ V.

Solution:

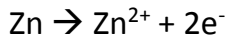

The Nernst equation for the oxidation half-cell reaction is

$$E_{cell} = E_{cell}^{\circ} - \frac{0.059}{2} \log[\text{Zn}^{2+}]$$

The number of electrons transferred $n = 2$ and $E^\circ = 0.763$ V.

Substituting these values in the Nernst equation we have

$$E_{cell} = 0.763 - \frac{0.059}{2} \log[0.01]$$

$$E_{cell} = 0.763 + 0.059 = 0.822\text{V}$$

Q) Calculate the emf of the cell.

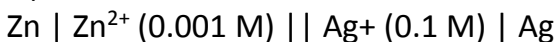

The standard potential of Ag/Ag⁺ half-cell is + 0.80 V and Zn/Zn²⁺ is -0.76 V.

Solution:

Cell reaction is

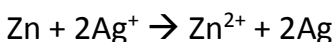

Zn|Zn²⁺ is anode and its reduction potential is = -0.76 V

Ag|Ag⁺ is cathode and its reduction potential is = +0.80 V

Emf of the cell = Reduction potential of Cathode - Reduction potential of Anode

$$\text{Emf of the cell} = +0.8 - (-0.76) = 1.56$$

Applying Nernst equation to the net cell reaction gives

$$E_{cell} = E_{cell}^{\circ} - \frac{0.059}{2} \log \frac{c_2}{c_1^2}$$

C_2 is concentration of anode solution and C_1 is concentration of cathode solution

$$E_{cell} = 1.56 - \frac{0.059}{2} \log \frac{0.001}{(0.1)^2}$$

$$E_{cell} = 1.56 - \frac{0.059}{2} \log 10^{-1}$$

$$E_{cell} = 1.56 + 0.02955 = 1.58955 \text{ V}$$

Relation between standard free energy and equilibrium constant

Let us assume that the redox changes occurring in Daniell cell attains equilibrium. At equilibrium, the reduction potential values of the two electrodes become equal and EMF of the cell becomes zero

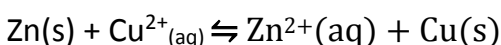

The equilibrium constant for this reaction is given as

$$K_{eq} = \frac{[Zn^{2+}]}{[Cu^{2+}]}$$

Applying Nernst equation to the complete cell reaction

$$E_{cell} = E_{cell}^0 - \frac{RT}{nF} \ln \frac{[Zn^{2+}]}{[Cu^{2+}]}$$

$$E_{cell}^0 = -\frac{RT}{nF} \ln \frac{[Zn^{2+}]}{[Cu^{2+}]} \quad [as \ E_{cell} = 0]$$

$$nFE_{cell}^0 = RT \ln K_{eq} \quad \text{---- eq(1)}$$

$$\log K_{eq} = \frac{nE_{cell}^0}{0.059} \quad \text{--- eq(2)}$$

$$\text{Since } nFE_{cell}^0 = -\Delta G^0$$

From equation (1)

$$\therefore -\Delta G^0 = RT \ln K_{eq}$$

$$\Delta G^0 = -2.03RT \log K_{eq} \quad \text{-----eq(3)}$$

Q) Calculate the equilibrium constant for the reaction between silver nitrate and metallic zinc. $E_{cell}^0 = 1.56$

Solution :

Cell reaction

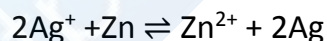

$$\log K_{eq} = \frac{nE_{cell}^0}{0.059}$$

$$\log K_{eq} = \frac{2 \times 1.56}{0.059} = 52.79$$

$$K_{eq} = 6.19 \times 10^{52}$$

Q) Calculate the E.M.F. of the zinc - silver cell at 25°C when $[Zn^{2+}] = 0.10$ M and $[Ag^+] = 10$ M. (E_{cell}^0 at 25°C = 1.56 volt)

Solution : The cell reaction in the zinc - silver cell would be

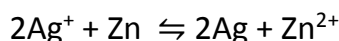

The Nernst equation for the above all reaction may be written as :

$$E_{cell} = E_{cell}^0 - \frac{0.059}{2} \log \frac{[Zn^{2+}]}{[Ag^+]^2}$$

$$E_{cell} = 1.56 - \frac{0.059}{2} \ln \frac{[0.10]}{[10]^2}$$

$$E_{\text{cell}} = 1.648 \text{ V}$$

Concentration cells

The cells whose E_{cell}^0 is zero are called concentration cells. This means that the two compartments (cathode and anode) of the electrochemical cell involve same chemical species but the concentrations of the chemical species in the two compartments are different. The concentration cells are basically two types

- Electrolyte concentration cells and
- Electrode concentration cells

Electrolyte concentration cells

In such cells, two electrodes of the same metal are dipped in solutions of metal ions of different concentrations. Let an electrochemical cell represented as

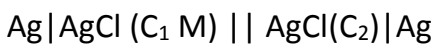

For the given cell

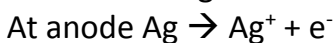

Applying Nernst equation to the net cell reaction gives

$$E_{\text{cell}} = E_{\text{cell}}^0 - \frac{0.059}{2} \log \frac{c_2}{c_1}$$

Since both anode and cathode are of same elements $E_{\text{cell}}^0 = 0$

$$E_{\text{cell}} = - \frac{0.059}{2} \log \frac{c_2}{c_1}$$

The net cell reaction is spontaneous only when EMF of the cell is positive, which is possible only when concentration of cathode compartment is (C_2) is greater than the concentration of anode compartment (C_1). Higher concentration compartment will act as cathode.

Electrode concentration cells

In such cells, two similar electrodes at different concentrations/ pressures are dipped in the same solution with similar concentration.

Let us have an electrochemical of the electrode concentration cell is that of an amalgam with two different concentrations of the same metal dipped in same electrolyte solution

The cell is represented as



The reaction for the given cell are

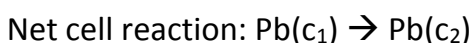
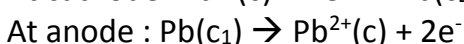
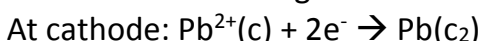

Since, the concentration of Pb^{2+} for the two half cells is same as the electrolyte solution for the two compartments is same, so the net reaction is independent of the electrolyte concentration.

Applying Nernst equation to the net cell reaction gives

$$E_{cell} = E_{cell}^0 - \frac{0.059}{2} \log \frac{c_2}{c_1}$$

Since $E_{cell}^0 = 0$

$$E_{cell} = -\frac{0.059}{2} \log \frac{c_2}{c_1}$$

The net cell reaction would be spontaneous, when The emf of the cell is positive, which is possible only when $C_1 > C_2$

i.e electrode with more concentration will act as anode

Solved numerical

Given overall formation of the $[\text{Fe}(\text{CN})_6]^{4-}$ ion as 10^{35} and the standard potential for half reactions

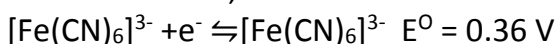
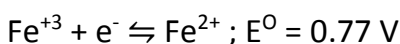

Calculate the overall formation constant of the $[\text{Fe}(\text{CN})_6]^{3-}$ ion

Solution

Let K_f be the formation constant of $[\text{Fe}(\text{CN})_6]^{3-}$ ion

A) $\text{Fe}(\text{CN})_6]^{4-}$ is formed by following reaction

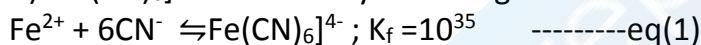

From the relation $\Delta G^0 = 2.303RT \log K_f$ for above equation

$$\Delta G_1^0 = -2.303RT \log K_f \quad (T = 398\text{K}, R = 8.314 \text{ J/mol})$$

$$\Delta G_1^0 = 2.303 \times 8.314 \times 398 \log 10^{35} = -199704.69 \text{ J}$$

B) $\text{Fe}^{+3} + e^- \rightleftharpoons \text{Fe}^{2+}; E^0 = 0.77\text{V} \quad \text{-----eq(2)}$

From equation $\Delta G^0 = -nFE$ for equation $n=1$

$$\Delta G_2^0 = -1 \times 96500 \times 0.77 = -74305 \text{ J}$$

C) $[\text{Fe}(\text{CN})_6]^{3-} + e^- \rightleftharpoons [\text{Fe}(\text{CN})_6]^{4-}; E^0 = 0.36 \text{ V}$

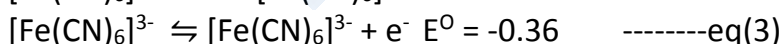

From equation $\Delta G^0 = -nFE$ for equation $n=1$

$$\Delta G_3^0 = -1 \times 96500 \times (-0.36) = 34740 \text{ J}$$

Adding equation (1), (2) and (3)

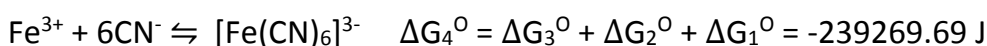
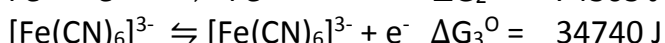
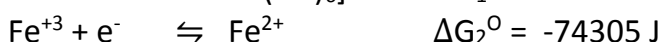
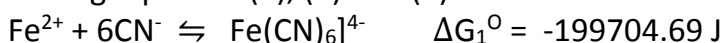

Now

$$\Delta G_4^0 = -2.03RT \log K_f$$

$$K'_f = 8.59 \times 10^{41}$$

Q) By how much is the oxidizing power of the $MnO_4^- | Mn^{2+}$ couple decreases if the H^+ concentration is decreased from 1M to $10^{-4}M$ at $25^\circ C$? Assume that the concentration of other species do not change

Solution

In acidic medium, MnO_4^- acts as oxidizing agent and reduce to Mn^{2+} as per the reaction

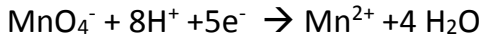

$$E_{MnO_4^- | Mn^{2+}} = E_{MnO_4^- | Mn^{2+}}^0 - \frac{0.059}{5} \log \frac{[Mn^{2+}]}{[MnO_4^-][H^+]^8}$$

$$E_{MnO_4^- | Mn^{2+}} = E_{MnO_4^- | Mn^{2+}}^0 - \frac{0.059}{5} \log \frac{[Mn^{2+}]}{[MnO_4^-][1]^8}$$

And

$$E_{MnO_4^- | Mn^{2+}} = E_{MnO_4^- | Mn^{2+}}^0 - \frac{0.059}{5} \log \frac{[Mn^{2+}]}{[MnO_4^-][10^{-4}]^8}$$

$$\therefore \Delta E_{MnO_4^- | Mn^{2+}} = \frac{0.059}{5} \log \left[\frac{[MnO_4^-][1]^8}{[Mn^{2+}]} \times \frac{[Mn^{2+}]}{[MnO_4^-][10^{-4}]^8} \right]$$

$$\therefore \Delta E_{MnO_4^- | Mn^{2+}} = 0.3776V$$

Thus, the oxidizing power of $MnO_4^- | Mn^{2+}$ couple **decreases** by 0.3776V

Q) The potential of the following cell is 1.02 V at 298K temperature Calculate the pH of the HCl solution ($E_{Ag}^0 = 0.8 V$)

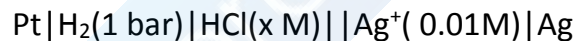

Solution

Reduction potential is given

$$E_{\text{Cell}}^0 = \text{Reduction potential of cathode} - \text{Reduction potential of anode}$$

$$E_{\text{Cell}}^0 = 0.8 - 0 = 0.8 V$$

Cell reaction

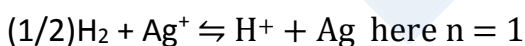

$$E_{\text{cell}} = E_{\text{cell}}^0 - \frac{0.059}{n} \log \frac{[H^+]}{[Ag^+]}$$

$$1.02 = 0.80 - \frac{0.059}{1} \log \frac{[H^+]}{[0.01]}$$

$$3.729 = -\log[H^+] + (-2)$$

$$-\log[H^+] = 5.729$$

$$\text{pH} = 5.729$$

Q) EMF of the following cell is 0.67V at 298K

Pt | H₂ (1atm) | H⁺(pH=X) | | KCl(1N) | Hg₂Cl₂ | Hg

Calculate pH of the anode compartment. Given $E^{\circ}_{Cl|Hg_2Cl_2|Hg} = 0.28V$

Solution

Anode reaction $H_2 \rightarrow 2H^+ + 2e^-$

Cathode reaction $Hg_2Cl_2 + 2e^- \rightarrow 2Hg + 2Cl^-$

Cell reaction

$H_2 + Hg_2Cl_2 \rightarrow 2H^+ + 2Hg + 2Cl^-$

$$E_{cell} = E^{\circ}_{Cl^-|Hg_2Cl_2|Hg} - E^{\circ}_{H^+|H_2} - \frac{0.059}{2} \log \frac{[H^+]^2 [Cl^-]^2}{H_2}$$

(Hg and Hg₂Cl₂ are pure solids hence don't appear)

[Cl] = 1 as KCl is 1N and [H₂] = 1 atm

$$0.67 = 0.28 - 0 - \frac{0.059}{2} \log \frac{[H^+]^2 [1]^2}{1}$$

$$0.67 = 0.28 - 0.059 \log[H^+]$$

$$-\log[H^+] = 6.61$$

$$pH = 6.61$$

Q) The emf of the cell, Hg | Mercurous nitrate (0.01M) | | Mercurous nitrate (0.1M) | Hg was found to be 0.0295V at 250°. Calculate the molecular formula of mercurous nitrate.

Solution

Let the formula of mercurous nitrate be Hg_n(NO₃)_n

For the given cell, the reactions occurring at two electrodes are

At anode : $nHg \rightarrow (Hg_n^{n+})_A + ne^-$

At cathode : $(Hg_n^{n+})_C + ne^- \rightarrow nHg$

Net cell reaction : $(Hg_n^{n+})_C \rightarrow (Hg_n^{n+})_A$

So, this is an electrolyte concentration cell for which $E^{\circ}_{cell} = 0$. The E_{cell} will be given as

$$E_{cell} = - \frac{0.059}{n} \log \frac{[(Hg_n^{n+})_A]}{[(Hg_n^{n+})_C]}$$

$$0.0295 = - \frac{0.059}{n} \log \frac{0.1}{0.01}$$

$$0.0295 = \frac{0.059}{n} \log \frac{0.01}{0.00.1}$$

$$n = 2$$

Thus , the formula of mercurous nitrate is Hg₂(NO₃)₂

Q) Find the solubility product of a saturated solution of Ag₂CrO₄ in water at 298 K, if the emf of the cell,

Ag | Ag⁺(std. Ag₂CrO₄ solution) | | Ag⁺(0.1M) | Ag is 0.164V at 298K

Solution

For the given cell, the reaction occurs at anode and cathode are



Thus it is an electrolyte concentration cell with $E^\circ_{\text{cell}} = 0$

$$\therefore E_{\text{cell}} = -\frac{0.059}{1} \log \frac{[\text{Ag}^+_A]}{[\text{Ag}^+_C]}$$

$$E_{\text{cell}} = \frac{0.059}{1} \log \frac{[\text{Ag}^+_C]}{[\text{Ag}^+_A]}$$

The anode compartment have saturated solution of Ag_2CrO_4 , supplying Ag^+ ion concentration.

Let the solubility of Ag_2CrO_4 be 'x' moles/lit

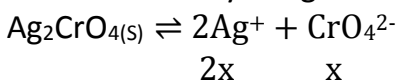

$$K_{SP} = [\text{Ag}^+_A]^2 [\text{CrO}_4^{2-}] = (2x)^2 x = 4x^3$$

$$x = \sqrt[3]{\frac{K_{SP}}{4}}$$

$$[\text{Ag}^+_A] = 2x$$

$$[\text{Ag}^+_A] = 2 \times \sqrt[3]{\frac{K_{SP}}{4}}$$

$$\therefore E_{\text{cell}} = \frac{0.059}{1} \log \frac{0.1}{2 \times \sqrt[3]{\frac{K_{SP}}{4}}}$$

$$0.164 = \frac{0.059}{1} \log \frac{0.1}{2 \times \sqrt[3]{\frac{K_{SP}}{4}}}$$

$$K_{SP} = 2.24 \times 10^{-12} \text{M}^3$$

Type of batteries

A battery is an electrochemical cell, or a series of combined electrochemical cells, that can be used as source of direct electric current at a constant voltage. The operation of a battery is similar in principle to that of the electrochemical cells except that they are completely self contained and require no salt bridge. There are generally two types of batteries. Primary batteries and secondary batteries

A primary battery act as a source of electricity without being previously charged by an electric current from external source. In such battery, electrical energy is obtained at the expense of chemical reactivity as long as the active materials are present. A battery, which can be recharged after it has been used once is called secondary battery. Certain chemical changes occur when the cell is charged with electricity and these changes are reversed during discharge process

Dry Cell Batter

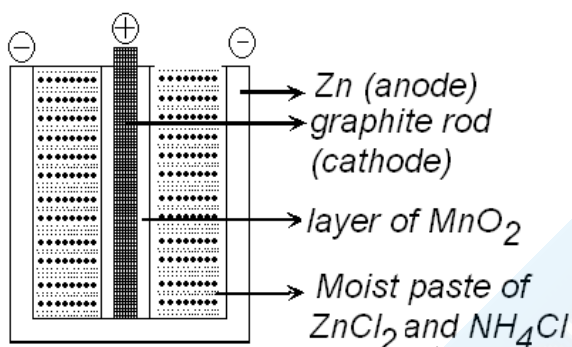

The most familiar example of this type is the dry cell (known as Leclanche cell after its discoverer) which is used commonly in our transistors and clocks.

The cell consists of a zinc container that also acts as anode and the cathode is a carbon (graphite) rod surrounded by powdered manganese dioxide and carbon (Fig). The space between the electrodes is filled by a moist

paste of ammonium chloride (NH_4Cl) and zinc chloride (ZnCl_2). The electrode reactions are complex, but they can be written approximately as follows.

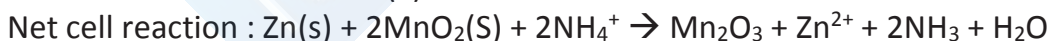
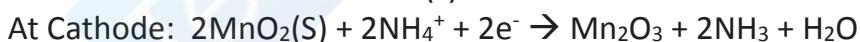

In the reaction at cathode, manganese is reduced from the + 4 oxidation state to the +3 state. Ammonia produced in the reaction forms a complex with Zn^{2+} to give $[\text{Zn}(\text{NH}_3)_4]^{2+}$. The cell has a potential of nearly 1.5 V.

Mercury cell

Mercury cell, suitable for low current devices like hearing aids, watches, etc. consists of zinc – mercury amalgam as anode and a paste of HgO and carbon as the cathode.

The electrolyte is a paste of KOH and ZnO . The electrode reactions for the cell are given below:

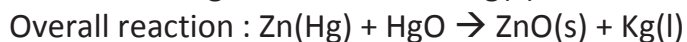
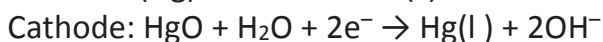
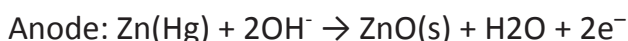

The cell potential is approximately 1.35 V and remains constant during its life as the overall reaction does not involve any ion in solution whose concentration can change during its life time.

Secondary cell

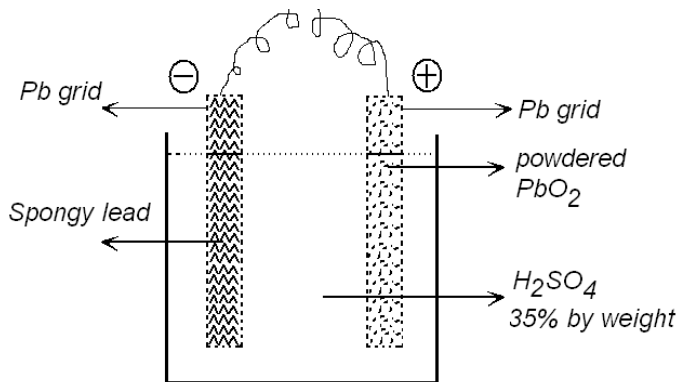

Lead storage battery

A secondary cell after use can be recharged by passing current through it in the opposite direction so that it can be used again. A good secondary cell can undergo a large number of discharging and charging cycles.

The most important secondary cell is the lead storage battery commonly used in automobiles and invertors. It consists of a

lead anode and a grid of lead packed with lead dioxide (PbO_2) as cathode. A 38% solution of sulphuric acid is used as an electrolyte.

The cell reactions when the battery is in use are given below:

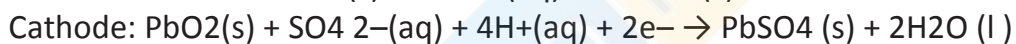
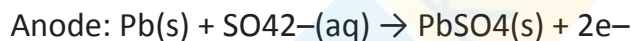

i.e., overall cell reaction consisting of cathode and anode reactions is:



On charging the battery the reaction is reversed and $\text{PbSO}_4(\text{s})$ on anode and cathode is converted into Pb and PbO_2 , respectively

Under normal operating conditions, each cell produce potential of 2V. Thus a total of 12V from six cells.

The cell reaction are easily reversed, if PbSO_4 is freshly precipitated, but on long standing, PbSO_4 changes its crystalline structure and ages to less reactive form, which cannot be reconverted back into Pb and PbO_2

Four aspects are noteworthy

(i) There is no salt bridge and both the electrodes are immersed in the same solution.

(ii) Battery is rechargeable i.e normal electrochemical reactions are reversed by applying an external voltage at the cathode and the anode.

(iii) As the battery is used, the electrolyte solution becomes more dilute as H_2O is produced and H_2SO_4 is used up. Thus, the density of electrolyte solution decreases and the degree to which the battery has been discharged can be checked by measuring the density of the electrolyte

(iv) The temperature coefficient for lead storage battery is $1.5 \times 10^{-4} \text{ V}/^\circ\text{C}$.

Thus even for 40°C change in temperature, the decrease in voltage amount to only $6 \times 10^{-3} \text{ V}$, which is about 0.05% of the operating voltage

Nickel-Cadmium battery

Nickel-cadmium cell has longer life than the lead storage cell but more expensive to manufacture.

The reaction at two electrodes are

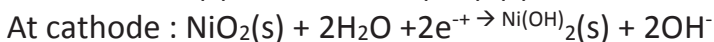

Net cell reaction while discharging is



Solved numerical

Q) A lead storage cell is discharged which causes the H_2SO_4 electrolyte to change from a concentration of 34.6% by weight (density 1.261 g mL^{-1} at 25°C) to one of 27% by weight. The original volume of the electrolyte is one litre. Calculate the total charge released at anode of the battery. Note that the water is produced by the cell reaction as H_2SO_4 is used up. Overall reaction is

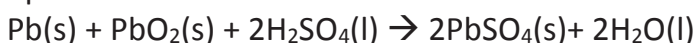

Solution

Before the discharge of lead storage battery

$$\text{Mass of solution} = 1000 \times 1.261 = 1261 \text{ g}$$

$$\text{Mass of H}_2\text{SO}_4 = (1261 \times 34.6) / 100 = 436.3 \text{ g}$$

$$\text{Mass of water} = 1261 - 436.3 = 824.7 \text{ g}$$

After the discharge of lead storage battery

Let the mass of H_2O produced as a result of net reaction during discharge is 'x' g

Since it is a mole to mole relation between H_2SO_4 and water

$$\text{Moles of H}_2\text{O produced} = \text{moles of H}_2\text{SO}_4 \text{ consumed} = x/18$$

$$\text{Mass of H}_2\text{SO}_4 \text{ consumed} = (x/18) \times 98$$

Now mass of the solution after discharge =

$$1261 - \frac{98x}{18} + x$$

% by mass of H_2SO_4 after discharge =

$$\frac{\text{Mass of H}_2\text{SO}_4 \text{ left}}{\text{Mass of solution after discharge}} \times 100 = 27$$

$$27 = \frac{436.3 - \frac{98x}{18}}{1261 - \frac{98x}{18} + x} \times 100$$

$$X = 22.59 \text{ g}$$

From the reaction, it is evident that the moles of electron exchanged at anode or cathode is two and this is also the moles of H_2O produced or moles of H_2SO_4 consumed

\therefore moles of electrons released at anode =

$$\frac{22.59}{18}$$

\therefore total charge released at anode =

$$\frac{22.59}{18} \times 96500 = 1.21 \times 10^5 \text{ Coulomb}$$

Fuel cell

A hydrogen – oxygen fuel cell consists of an electrolyte solution, such as KOH solution and two inert carbon electrodes. Hydrogen and oxygen gases are bubbled through the anode and cathode compartments, where the following reaction takes place

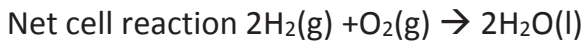
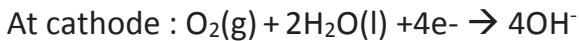
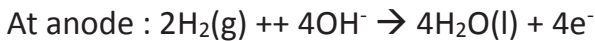

The standard emf of the cell is 1.23V, which indicates that the cell reaction is spontaneous under standard conditions, The porous carbon electrodes serves as electrical conduction and provide the necessary surface for the initial decomposition of the molecules into

atomic species prior to electron transfer. A hydrogen –oxygen fuel cell assembly is shown in figure

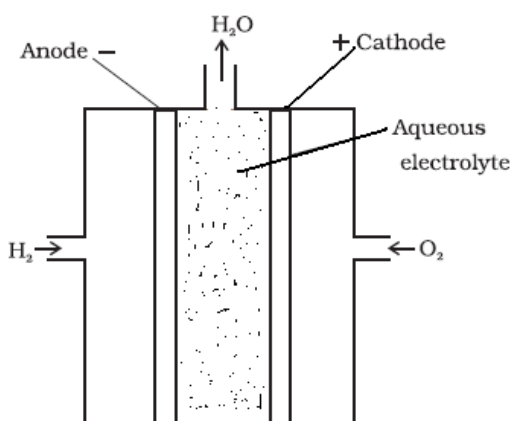

Unlike batteries, fuel cells do not store chemical energy. Reactants must be constantly resupplied and products must be constantly removed from fuel cell. The cell runs continuously as long as the reactants are supplied. Fuel cells produce electricity with an efficiency of about 70 % compared to thermal plants whose efficiency is about 40%. There has been tremendous progress in the development of new electrode materials,

better catalysts and electrolytes for increasing the efficiency of fuel cells.

These have been used in automobiles on an experimental basis. Fuel cells are pollution free and in view of their future importance, a variety of fuel cells have been fabricated and tried.

In corrosion, a metal is oxidised by loss of electrons to oxygen and formation of oxides. Corrosion of iron (commonly known as rusting) occurs in presence of water and air. The chemistry of corrosion is quite complex but it may be considered essentially as an electrochemical phenomenon.

At a particular spot (Fig) of an object made of iron, oxidation takes place and that spot behaves as anode and we can write the reaction

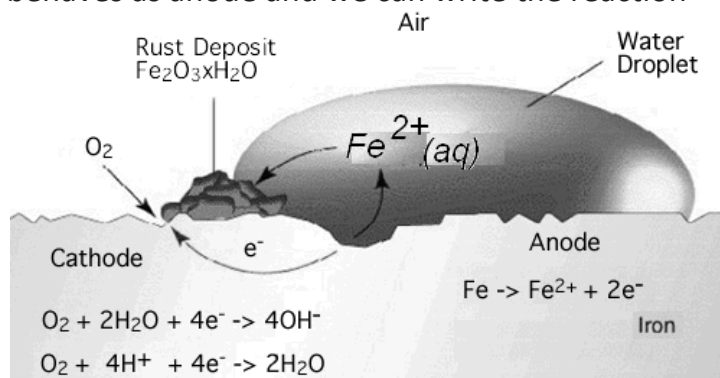

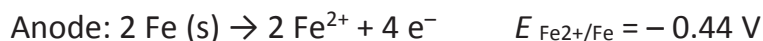

Electrons released at anodic spot move through the metal and go to another spot on the metal and reduce oxygen in presence of H^{+} (which is believed to be available from H_2CO_3 formed due to dissolution of carbon dioxide from air into water. Hydrogen ion in water may also be available due to dissolution of other acidic oxides from the atmosphere). This spot behaves as cathode with the reaction

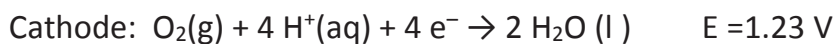

The overall reaction being:



The ferrous ions are further oxidised by atmospheric oxygen to ferric ions which come out as rust in the form of hydrated ferric oxide ($\text{Fe}_2\text{O}_3 \cdot x \text{H}_2\text{O}$) and with further production of hydrogen ions.

Prevention of corrosion is of prime importance. One of the simplest methods of preventing corrosion is to prevent the surface of the metallic object to come in contact with atmosphere. This can be done by covering the surface with paint or by some chemicals (e.g. bisphenol).

Another simple method is to cover the surface by other metals (Sn, Zn, etc.) that are inert or react to save the object. An electrochemical method is to provide a sacrificial electrode of another metal (like Mg, Zn, etc.) which corrodes itself but saves the object.